

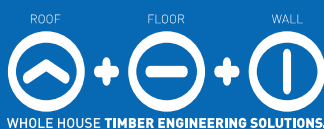

easi-joist[®]



METAL WEB FLOOR SYSTEM TECHNICAL GUIDE



CI/SfB

	(23.9)		
--	--------	--	--

Introduction

Wolf Systems provide products and services to the timber engineering industry. We manufacture and supply nailplates, metal webs and software for the design and manufacture of roof trusses, metal web joists and timber frame wall panels. Additionally, we also provide a comprehensive range of machinery for the manufacture of these components.

Company History

Wolf Systembau was started by Johann Wolf in 1966 in Scharnstein, Austria. The original activities of the company were construction within the agricultural industry. This consisted of concrete silos and buildings constructed of timber, steel and concrete. The company then expanded into other areas of the construction industry such as industrial, commercial and domestic buildings, manufacturing machinery for sawmills, timber frame wall panels and roof trusses, as well as harvesting timber from their own forests.

Having over 40 years experience in timber engineering, the Group operates from a state of the art office complex in Scharnstein, and employs 3000 staff in 14 European countries. Wolf Systembau is still privately owned by Johann Wolf and his family and all of the Group's operations are construction related.

In the United Kingdom and Ireland, Wolf Systems has a network of over 50 experienced trussed rafter manufacturers, supported by our comprehensive design and software, and specialist engineering office.

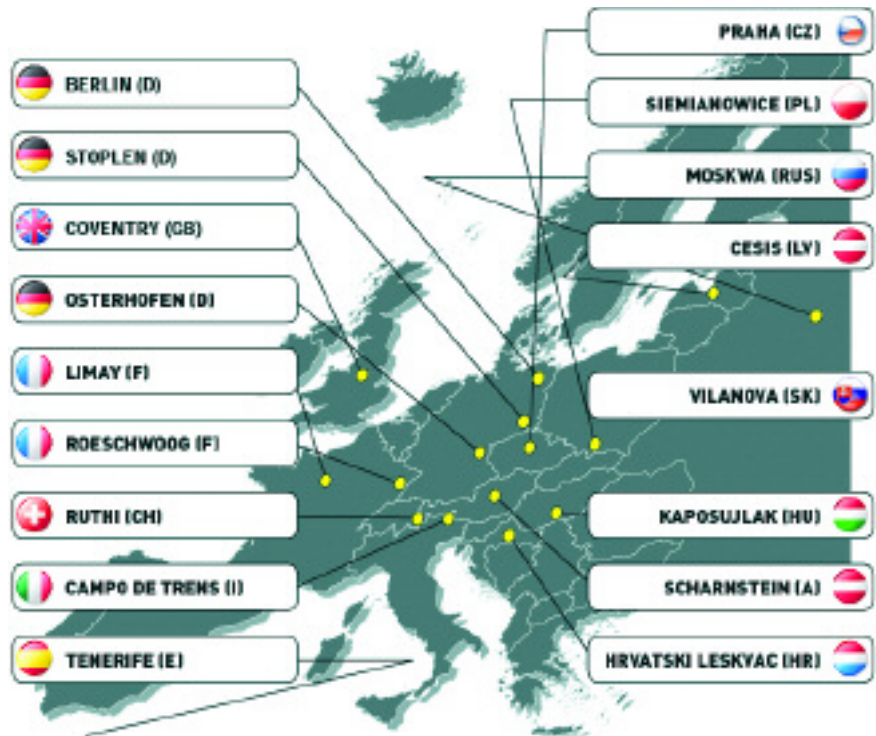

United Kingdom

Wolf Systems was formed in 1988 as an integral part of Wolf Systembau's expansion into the world roof truss systems market. Having successfully established itself amongst its competitors, Wolf Systems now has a network of over 50 experienced trussed rafter manufacturers throughout the United Kingdom and Ireland.

Following the introduction of our market leading roof truss design software, we turned our expertise and knowledge of timber engineering to products and services for Floors and Walls. Expanding on the simple yet

comprehensive interface found in the Roof software, *east-joist* has fast become adopted by many of our existing customers, and significantly manufacturers using competitor systems. Together with products for Roofs and Floors, our Wall panel software provides the complete solution for Whole House Timber Engineering design and manufacturing.

In addition to our products, our Customer Services and Design Team's provide expert technical support and backup for software implementation, training and design.



easi-joist®

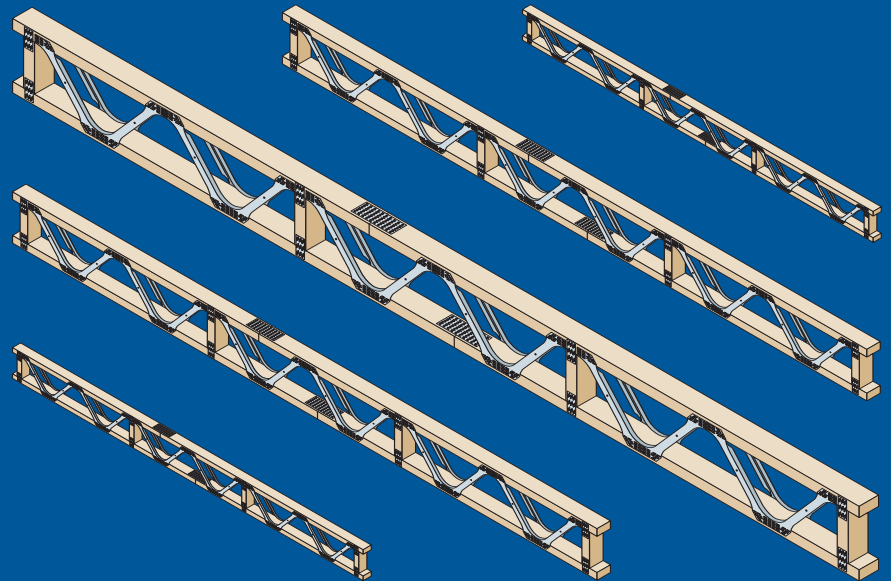

The easi-joist® floor system offers clear benefits over sawn timber and other engineered floor joist systems. Not only does it out-perform sawn timber in span and dimensional stability, the added benefits of a greater bearing area and open web system makes it easier to install for the carpenter, plumber and electrician, increasing valuable time and reducing cost.

Contents

The Company	2
Industry Associations, Standards and Compliance	4
The easi-joist® System	5-7
Accommodation of Services	8
Floor Cassettes	9
Approvals	10-13
Properties and Performance	14-15
Strongbacks and Restraint Straps	16
Ground Floor Joists	17
Floor Design Factors	18-19
Floor Detailing Key	20-21
General Floor Detailing	22-23
Floor detailing in Masonry Construction	24
Floor Detailing in Timber Frame Construction	25-27
Metalwork	28
Roof Detailing	29
Notes on Installation	30
Health and Safety	31-32
Index	33
Glossary of Terms	34
Design and Services	35

Industry Associations

Wolf recognise the importance of being associated with the leading bodies operating within our industry. Wolf Systems are active members of The Trussed Rafter Association (TRA), The UK Timber Frame Association (UKTFA), BMTRADA, and The Engineered Wood Products Committee.

Being associated with these organizations ensures Wolf's products and services are always provided in strict accordance with current standards and working practices.



The Trussed Rafter Association (TRA) is the respected voice of the trussed rafter industry in the UK. The Association is committed to stringent standards of quality and service and sets a professional benchmark for the industry.

Members include the principal manufacturers of trussed rafters, industry suppliers and professionals involved in roof design and construction.

TRA requires all its manufacturing members to have third-party supervised Quality Assurance and Professional Indemnity insurance so helping to ensure quality and peace of mind for the customer.



The Timber Research and Development Association (TRADA) is an internationally

recognised centre of excellence on the specification and use of timber and wood products.

TRADA is a company limited by guarantee and not-for-profit membership-based organisation. TRADA's origins go back over 70 years and its name is synonymous with independence and authority. Its position in the industry is unique with a diverse membership encompassing companies and individuals from around the world and across the entire wood supply chain, from producers, merchants and manufacturers, to architects, engineers and end users.



The UK Timber Frame Association (UKTFA) is the trade association representing over

85% of the UK timber frame manufacturers and also the sectors key suppliers. Established in 2002 they promote timber frame to the construction industry and the public; provide information and guidance, both technical and consumer; and aim to ensure that all sectors of UK construction fully exploit the benefits of timber frame.



The Irish Timber Frame Manufacturers' Association (ITFMA) is the Trade Association

for the timber frame manufacturing industry in Ireland. It is an independently constituted company limited by guarantee with no share capital. All full members are represented on the Board of Directors. Voting on issues is not based on turnover. The association is the recognised representative body for Timber Frame Manufacturers on the Island of Ireland and membership is synonymous with professionalism and quality. In addition, the ITFMA provide marketing, training and education of the timber frame concept.

Standards and Compliance



European Technical Approval is basically an assessment of a product to make sure it is fit for its intended use within each European Member State; in our case, the assessment of **east-joint** for use within domestic, industrial or commercial buildings.

This assessment is based on fulfilling the 6 essential requirements set out in the Construction Products Directive (CPD). There is no suitable design method for metal web joists in Eurocode 5 unlike trusses, hence the need for ETA to provide a harmonised design standard.

Wolf ETA Certificate No. ETA-07/0032



east-joint has been officially approved by Robust Details Ltd. under detail E-FT-3, this means that **east-joint** used in timber frame flats, constructed as per E-FT-3 will not require pre-completion sound testing to prove compliance with Part E of the Building Regulations in England & Wales; saving time, money and the uncertainty of pre-completion testing.



The Irish Agrément Board is designated by Government to issue European Technical Approvals.

Irish Agrément Board Certificates establish proof that the certified products are 'proper materials' suitable for their intended use under Irish site conditions, and in accordance with the Building Regulations 1997 to 2006.

The Irish Agrément Board operates in association with the National Standards Authority of Ireland (NSAI) as the National Member of UEAtc.

Wolf IAB Certificate No. 07/0280



ISO 9000 is the internationally recognised standard for an organisation's internal Quality

Management. The term 'quality' refers to all those features of a product or service which are required by the customer.

An organisation's 'Quality Management' refers to an organisation's actions to ensure that its products or services satisfy its customers' quality requirements and complies with any regulations applicable to those products or services.

Wolf Systems supplies all its products and services to ISO 9001 ensuring the highest standards are provided by our company.

east-joint is recognised for use in floor construction by the NHBC in the United Kingdom and Homebond in the Republic of Ireland.



NHBC is the standard setting body and leading warranty and

insurance provider for new and newly converted homes in the UK.



HomeBond is the national organisation which since 1978 has enabled Home Builders to provide their customers with

new home warranties and deposit and stage payments cover.

Introduction

The **easi-joist**® is a parallel chord truss utilising stress graded timber chords.

These chords are plated together with a precision engineered and manufactured structural component called the metal web and, when combined, form the **easi-joist**®.

The **easi-joist**® combines the lightness of timber with the structural qualities of metal. Together these two materials offer an opportunity for designing commercial, domestic and industrial floor applications with spans equal to and exceeding traditional timber joists and their equivalent timber alternatives, but with better damping and stiffness qualities.

easi-joist® is a precision designed and manufactured floor system, created to make floor joist manufacture faster, more cost effective and easier to install.

Timber

Timber used in the design of **easi-joists**® is kiln dried and stress graded, and complies with current European and British Standards.

Preservative

Joist timbers may be treated with waterborne solutions, or with non-corrosive spirit-based organic solvents. Copper chrome arsenate and similar treatments are not recommended.

Features

- Factory manufactured, made to measure.
- Long continuous spans, reducing or eliminating the need for intermediate support walls.
- Light and easy to handle.
- Increased spacing centres.
- Dimensional stability.
- Design accuracy through specialist software.
- Trimmable ends to facilitate installation where bearing support is inconsistent.
- Wide nailing surface making the nailing and gluing of decking quicker and more accurate.
- Improved floor performance.
- Stiffness and strength built into the floors improving floor rigidity.



The Benefits of easi-joist®

Open web design

This allows for easier, more practical, installation of services including waste water pipes, electrical cabling, heating pipes and other services. Also, no hole locating or drilling limits any possibility of incorrect workmanship and reduced labour costs.

Light weight

The combination of smaller timber sections with the lightweight metal web means that the finished product is lighter than timber and much lighter than timber equivalents.

Handling and installation

Large bearing surface allows a speedy set out of joists, improves joist stability when laying out joists and enables easier fixing of decking materials.

Reduced site wastage

The precision-manufactured **easi-joist**® virtually eliminates all site alterations, and standard timber sizes ensure materials are readily available.

Long-term stability

The reduced sections used in the manufacture of the **easi-joist**®, combined with the metal web mean that there is less loss of moisture and shrinkage, thus providing a quieter and longer lasting floor system.

Improved sound performance and reduced vibration

The metal web floor system allows for the installation of a rigid Strongback that reduces vibration and improves the overall acoustic performance of the floor.

Joist Definitions

(See glossary for details on definitions)

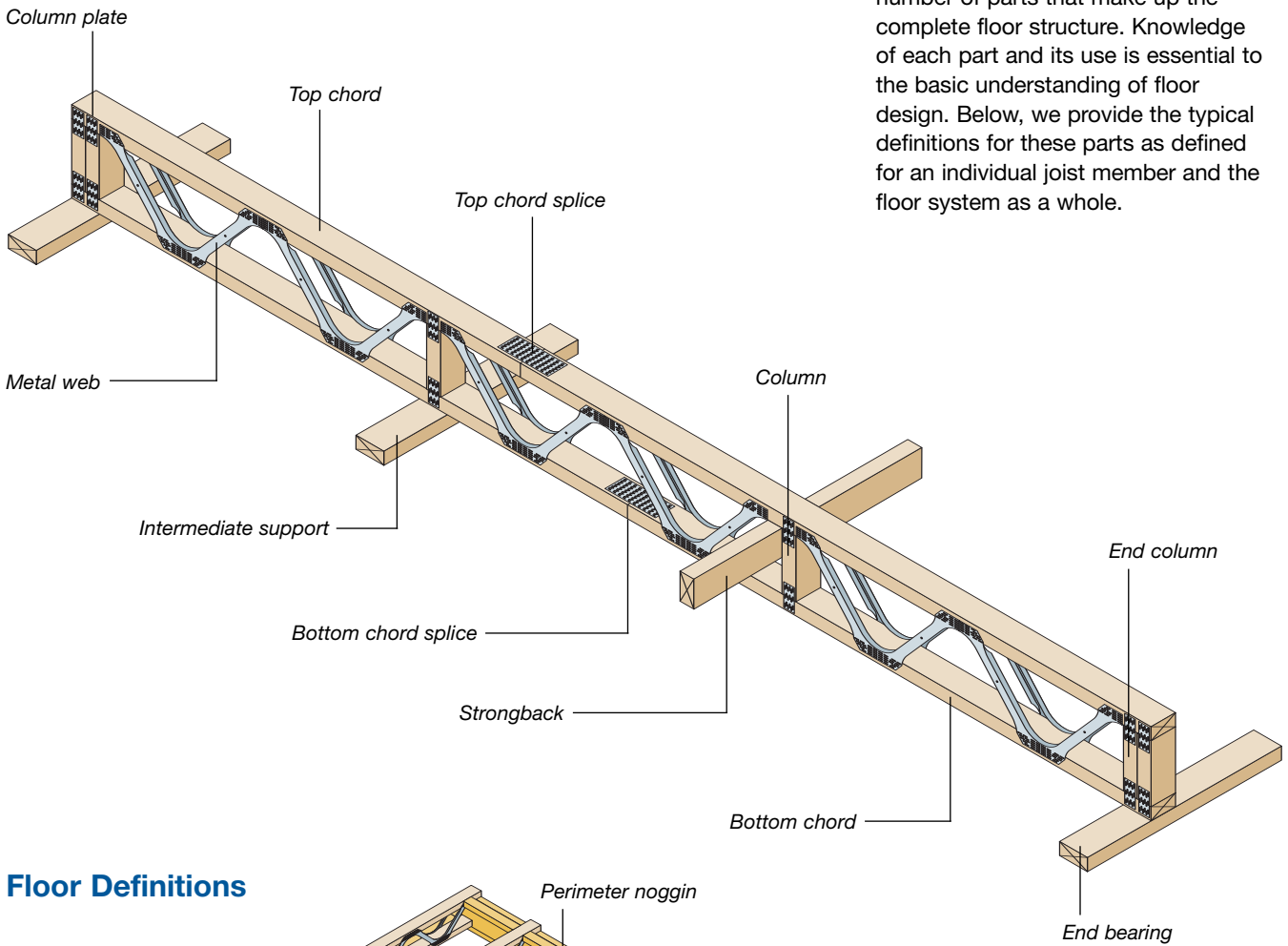

The **easi-joist**® system comprises a number of parts that make up the complete floor structure. Knowledge of each part and its use is essential to the basic understanding of floor design. Below, we provide the typical definitions for these parts as defined for an individual joist member and the floor system as a whole.

Floor Definitions

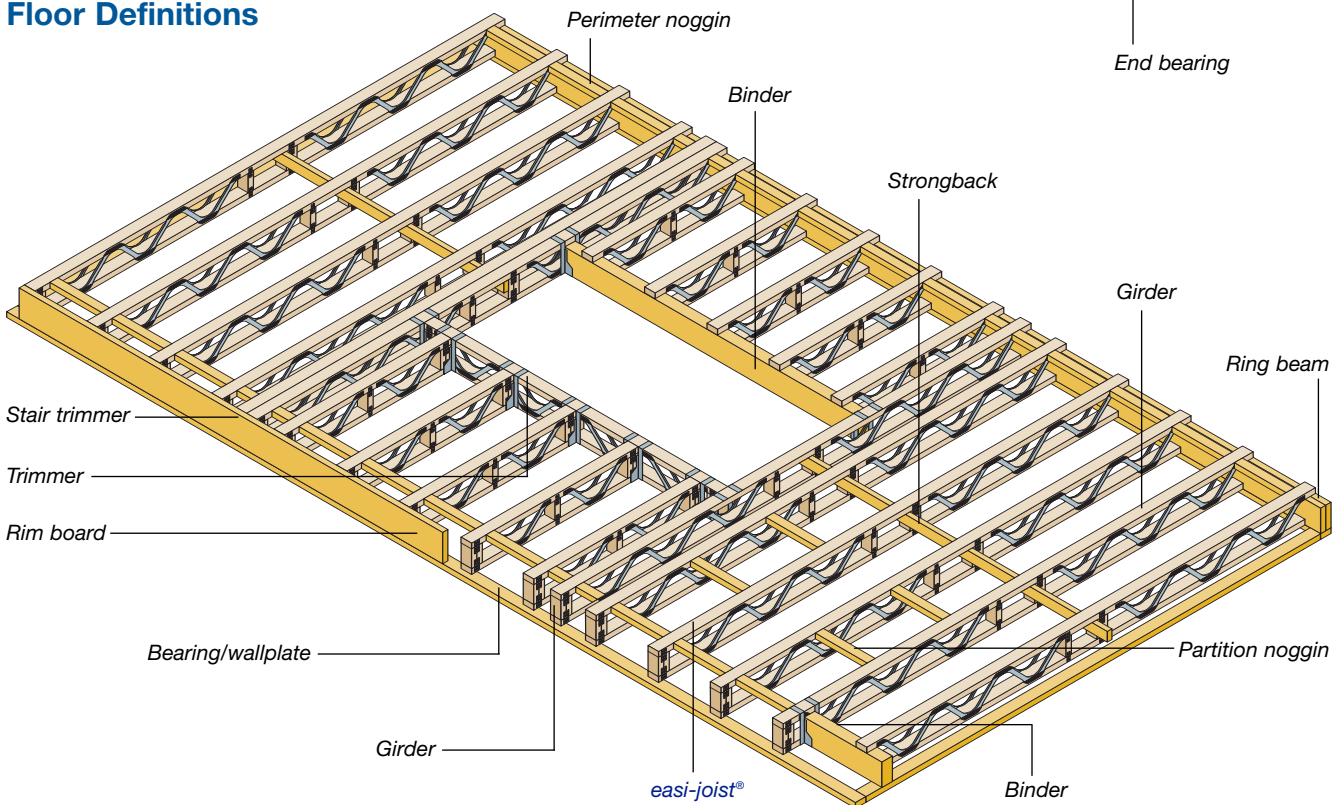

Joist Specification

(All dimensions in mm)

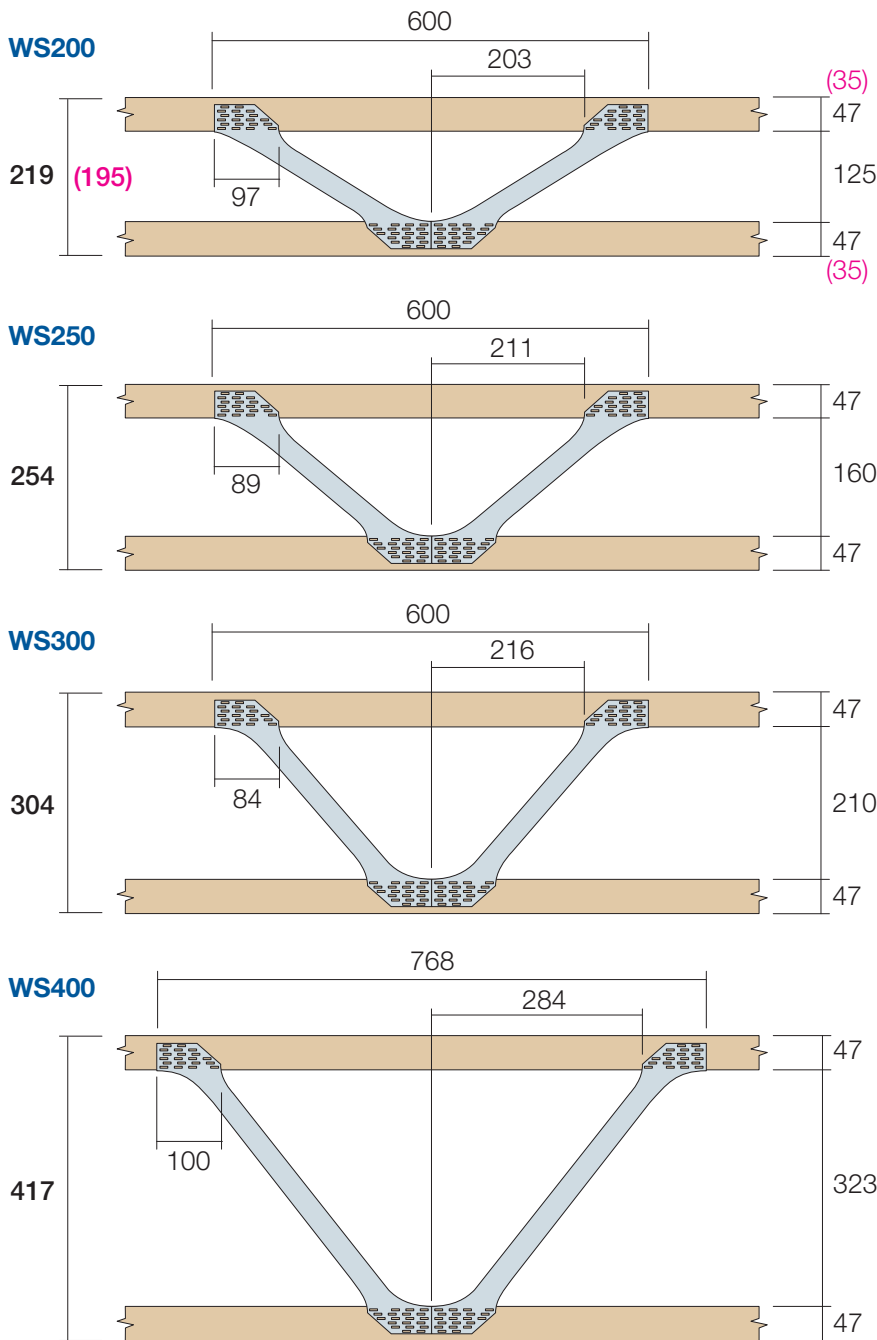

Joist widths

Single joist widths

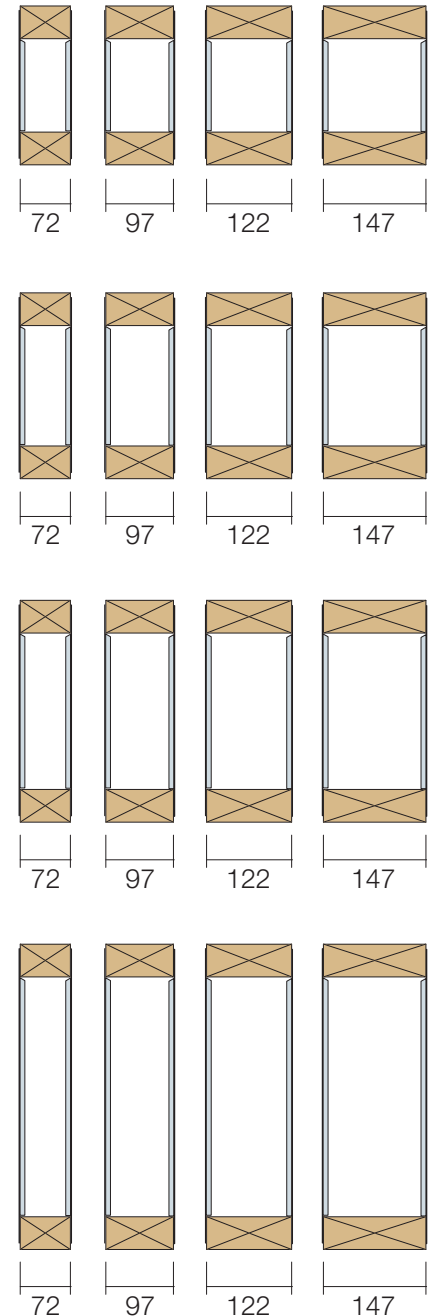

easi-joist' metal web joists are available in 5 different depths utilising 35mm and 47mm top and bottom timber chords.

Web code	Joist depth	Chord depth
WS200	195	35
WS200	219	47
WS250	254	47
WS300	304	47
WS400	417	47

Fixing

Fastening of multi-ply joists to be carried out to manufacturer's instructions using Cullen Timberlok or Simpson SDS screws.

Type and spacing as specified by **easi-joist'** software.

Multi-ply joist widths

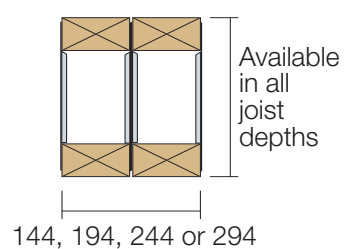

Accommodation of Services

'Easi-joist' is designed to allow for easy accommodation of electrical, plumbing, waste water and other services required within the floor joist area with no cutting or notching required.

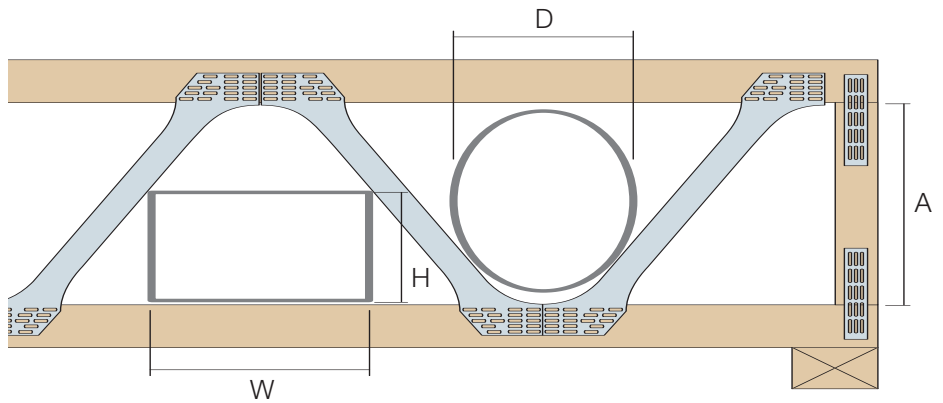
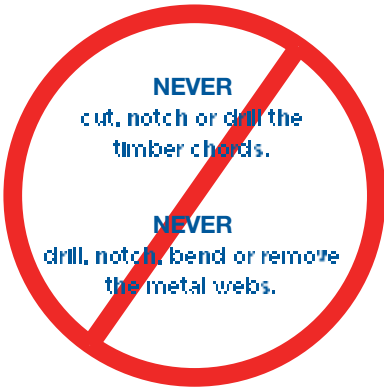

Clearance for circular services

	WS200	WS250	WS300	WS400
A (mm)	125	160	210	323
D (mm)	100	150	200	280

Clearance for rectangular services

	WS200	WS250	WS300	WS400
H mm	W mm	W mm	W mm	W mm
50	300	300	330	500
100	100	200	250	410
150	50	70	170	330
200	N/A	N/A	70	250
250	N/A	N/A	N/A	170
300	N/A	N/A	N/A	70

Accommodation of Services

A significant advantage of the **easi-joist** floor system is the open web design. The space provided by the metal web allows for the easy installation of services within the void.

Pipework, electrical cables and ducting can be easily routed through the joist space providing real time saving. By removing the laborious work needed for notching, drilling or cutting holes when using other joist systems the installation cost of services can be greatly reduced.

Furthermore, the curved edges of the webs and the absence of protruding plate edges removes any potential for damage when feeding through pipes and cables.

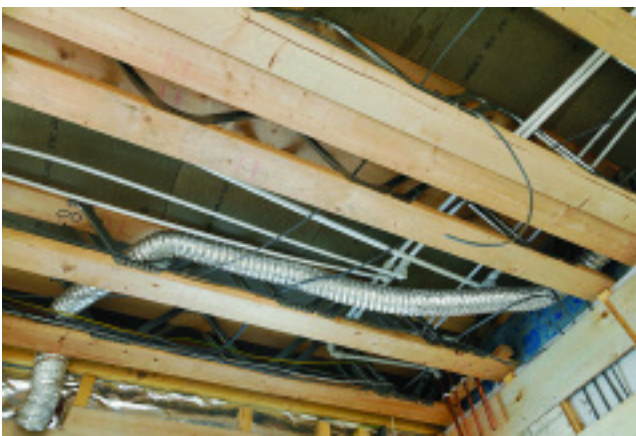

Along with traditional need to install ventilation services in bathrooms and kitchens, government initiatives for air tightness will require the installation of further mechanical systems for air exchange. The open web design provides an ideal zone for the passage of ducting for these devices.



Floor Cassettes

The benefits of off-site construction is widely recognised and the manufacture of floor cassettes is becoming increasingly more popular.

Floor cassettes offer numerous advantages over construction of the floor on-site, such as:

- Quality
- Control
- Speed of construction
- Space on site
- Site wastage

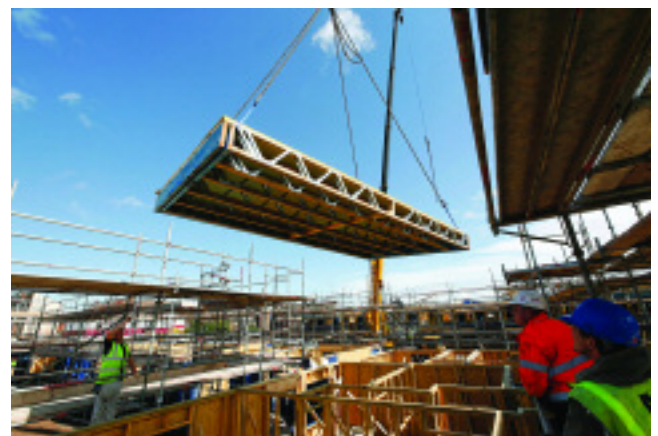

easi-joists are ideally suitable for the manufacture of floor cassettes. Along with the advantages on-site for the accommodation of services and long-term stability, the wide bearing surface makes it easier to lay out the joists in preparation for adding rimboard and decking for the completion of the finished floor cassettes.



Approvals

To supply **easi-joist**® in the UK and Ireland it has been necessary to ensure the floor system meets the requirements of The Building Regulations.

European Technical Approval (ETA)

After exhaustive tests carried out by BMTRADA, **easi-joist**® was the first metal web floor system to attain ETA approval.

Irish Agrément Board (IAB)

After satisfying the requirements of the IAB, **easi-joist**® has been approved for supply in the Republic of Ireland.



United Kingdom

Intermediate Floors

Typical detailing for intermediate floor construction using **easi-joist**®. See specification and detail below.

Intermediate Floor Construction Specification

- Joists: 219mm **easi-joist**® at 600mm centres.
- Ceiling: 15mm plasterboard fixed at 230mm centres as per manufacturer's specification with 38mm Gyproc drywall timber screws.
- Decking: 22mm tongued and grooved moisture resistant chipboard fixed with appropriate adhesive and screwed down at 200mm centres at the perimeter and 300mm centres on intermediate support using 51mm Gyproc drywall timber screws.

Intermediate Floor Construction Detail

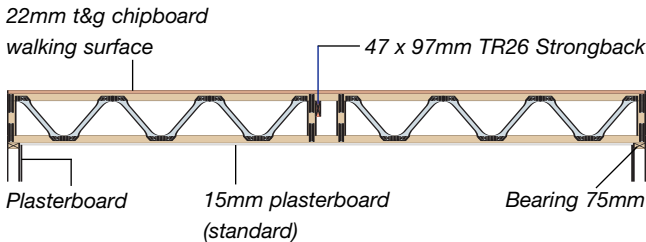

Fire Resistance (30 minutes)

The **easi-joist**® floor system has been tested in accordance with BS 476: Part 21: 1987 and achieved a fire resistance exceeding Requirement B3 of The Building Regulations.

Acoustic Performance

The **easi-joist**® floor system has been tested in accordance with BS EN ISO 140 – 3: 1995 and achieved a weighted airborne sound reduction index which exceeds Requirement E2 of The Building Regulations.

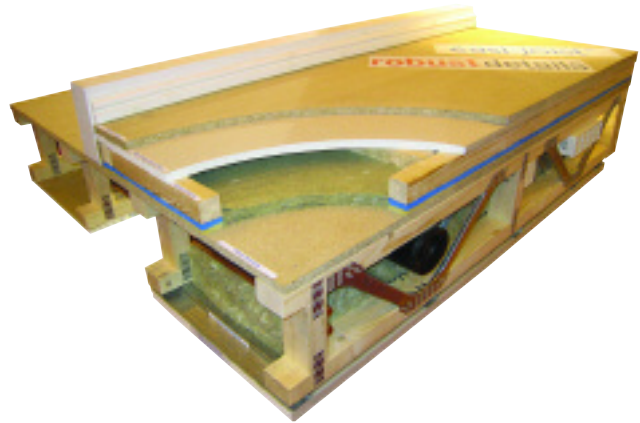

Separating Floors

Fire Resistance (60 minutes)

Typical detail of separating floor with 60 minute fire resistance.

60 minutes fire resistance can be achieved using either of the following ceiling treatments:

- Two layers of gypsum-based board, 19mm thick (nominal 13.5 kg/m²), and 12.5mm thick (nominal 10 kg/m²).
- Two layers of gypsum-based boards, each 15mm thick (nominal 11.7 kg/m²)

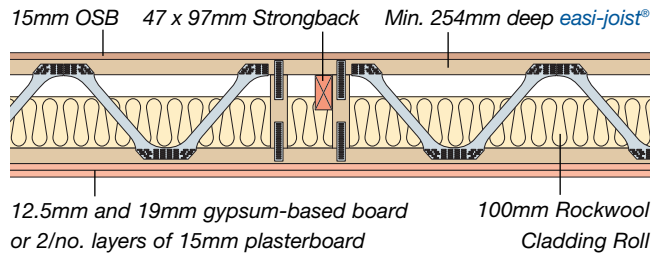

Separating floor construction: 60 minutes fire resistance

Acoustic Performance

Using Robust Details-approved **easi-joist**®, avoids the need to carry out pre-completion sound testing, eliminating the risk and uncertainty of remedial action being required on completed floor constructions. A Typical detail of separating floor, as approved by Robust Details, is shown below.

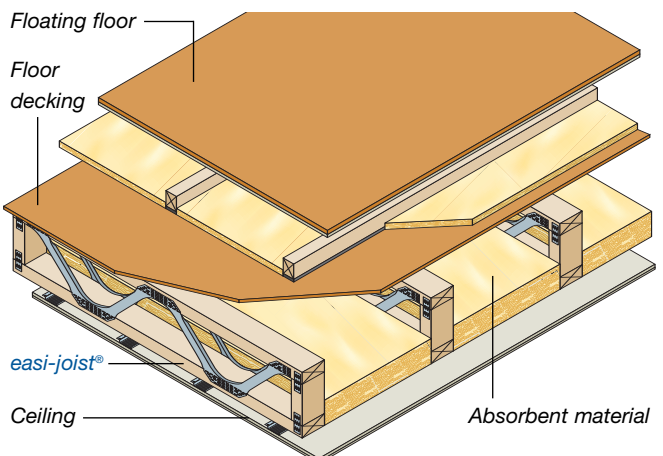

Separating floor construction (Robust Detail E-FT-3)



United Kingdom

Separating Floors (cont)

easi-joist[®] has been officially approved by Robust Details Ltd under detail E-FT-3. This means that **easi-joists**[®] used in timber frame flats, constructed as per E-FT-3, will not require pre-completion sound testing to prove compliance with Part E of the Building Regulations in England and Wales.

To ensure compliance, it is essential the floor is carefully constructed with specific floor and ceiling materials. See below for details.

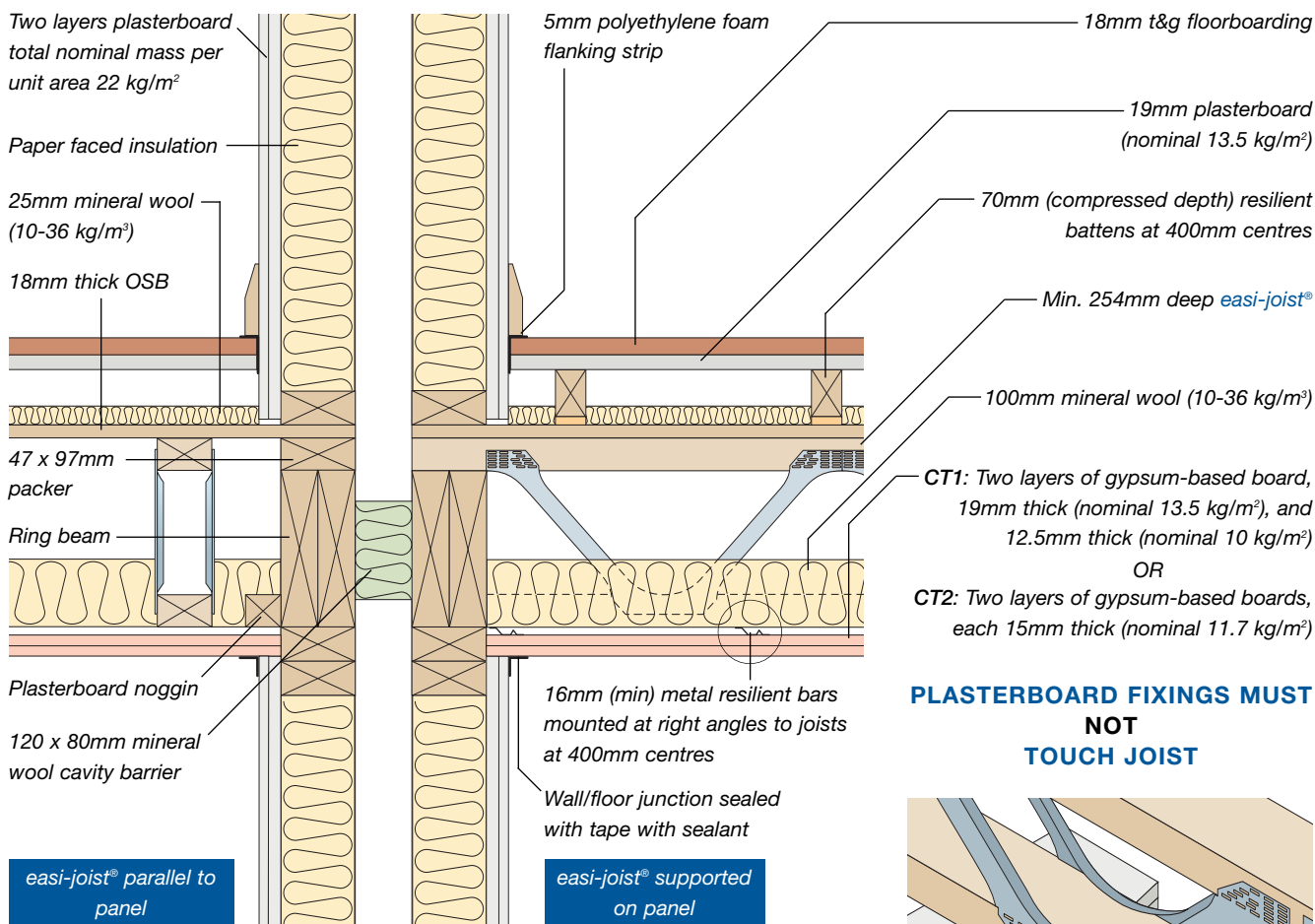

PLASTERBOARD FIXINGS MUST NOT TOUCH JOIST

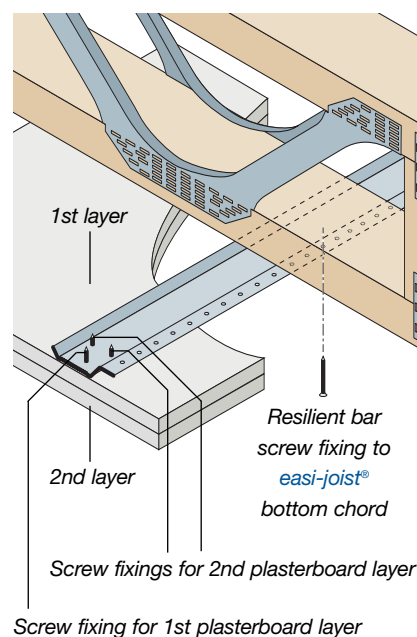

Resilient bar and plasterboard fixing

Separating floor construction (Robust Detail E-FT-3): 60 minutes fire resistance

Robust Detail loads

Top chord

- 1500 N/m² (Live load)
- 220 N/m² (Partitions)
- 475 N/m² (Robust makeup dead load)
 - 5mm polyethylene foam strip
 - 18mm t & g floor boarding
 - 19mm plasterboard
 - 70mm resilient battens
 - 25mm insulation (10-36 kg/m³)
 - 18mm OSB
 - Self weight

Bottom chord

- 366 N/m² (Robust makeup dead load)
 - 100mm mineral wool (10-36 kg/m³)
 - Resilient bars at 400mm centres
 - 2 layers plasterboard
 - Self weight

Note

This floor construction is for timber frame buildings only built in accordance with Robust Details and has not been approved for masonry construction. For further information on the **easi-joist**[®] robust detail, please contact Wolf Systems' Design Office



Republic of Ireland

Intermediate Floors

Typical detailing for intermediate floor construction using **easi-joist**[®]. See specification below and detail opposite.

Intermediate Floor Construction Specification

- Joists: 219mm **easi-joist**[®] at 400mm centres.
- Ceiling: 12.5mm plasterboard fixed at 230mm centres as per manufacturer's specification with 38mm Gyproc drywall timber screws. Ceiling finished with 3mm plaster skim coat.
- Decking: 18mm tongued and grooved moisture resistant chipboard fixed with appropriate adhesive and screwed down at 200mm centres using 4 x 45mm Gyproc drywall timber screws.

Intermediate Floor Construction Detail

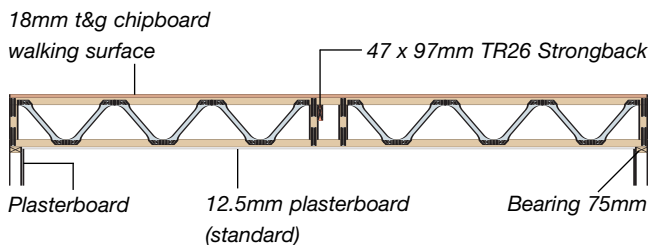

Fire Resistance (30 minutes)

The **easi-joist**[®] floor system has been successfully tested in accordance with BS 476: Part 21: 1987.

The fire resistance of floors incorporating **easi-joists**[®] varies according to the type of floor construction.

Acoustic Performance

The **easi-joist**[®] floor system has been tested in accordance with BS EN ISO 140 – 3: 1995 and achieved a weighted airborne sound reduction index which exceeds Requirement E2 of The Building Regulations.

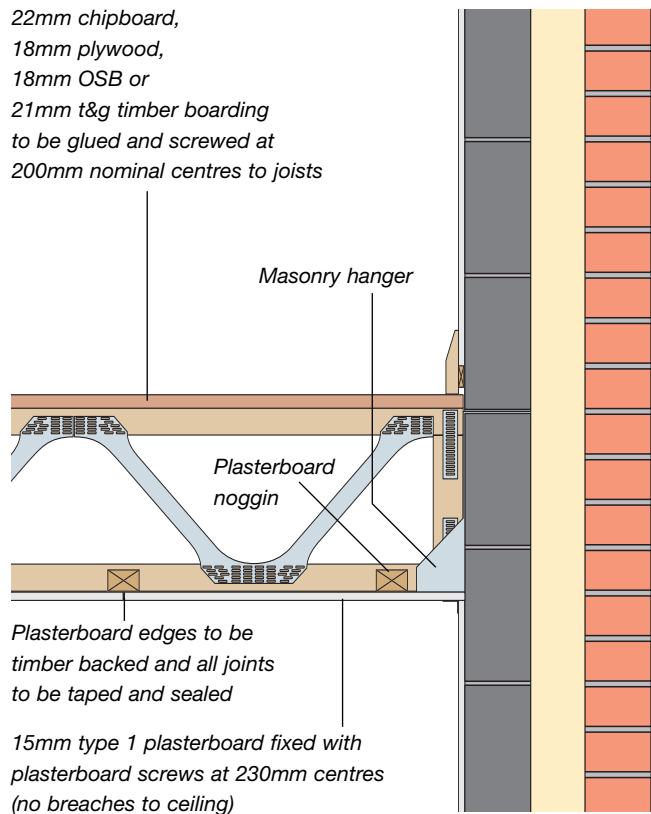

Intermediate floor construction: 30 minutes fire resistance with **easi-joists**[®] at more than 400mm centres

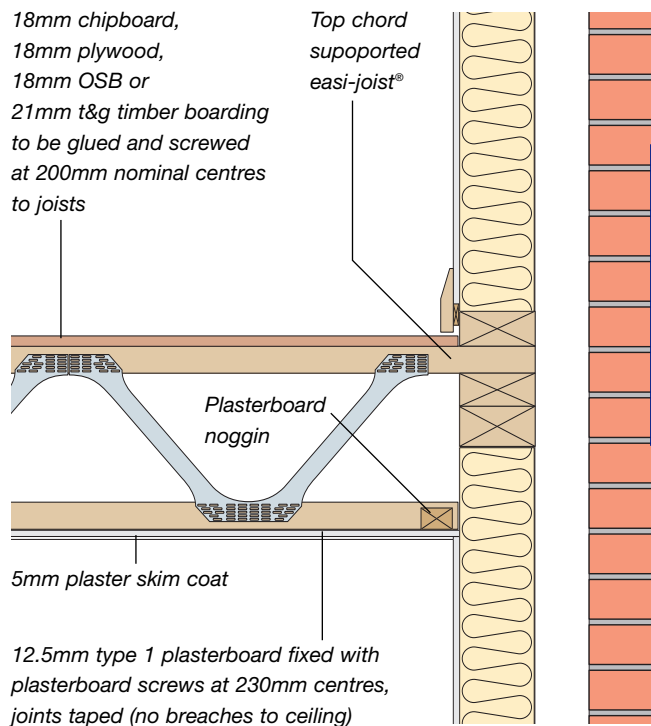

Intermediate floor construction: 30 minutes fire resistance with **easi-joists**[®] at 400mm centres

 Republic of Ireland

Separating Floors

Acoustic Performance

The type of floor construction used will determine the resistance to impact and airborne sound. Test data has been reviewed which indicates that the sound insulation properties of compartment floors, incorporating **easi-joist**, are at least as good as those of similar construction incorporating traditional joists.

The sound resisting properties depend on the sealing and integrity of the construction being maintained intact. Services and openings shall not be located within or through the voids unless specified in and installed strictly in accordance with the design drawings. Where openings are permitted, appropriate steps shall be taken to seal them, to achieve the required performance levels.

Fire Resistance (60 minutes)

The **easi-joist** floor system has been successfully tested in accordance with BS 476: Part 21: 1987.

See illustration below for typical detailing of separating floor with 60 minute fire resistance.

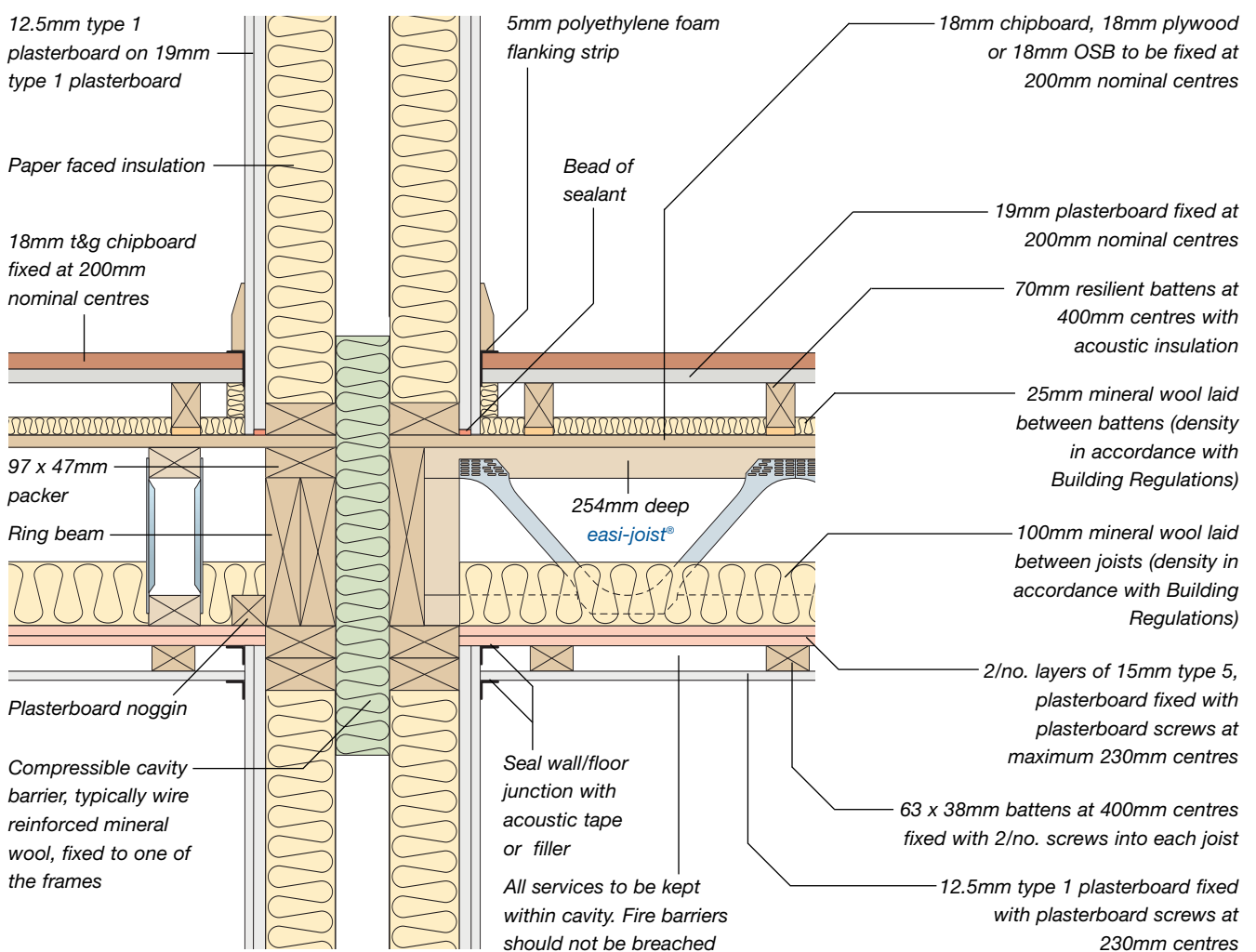
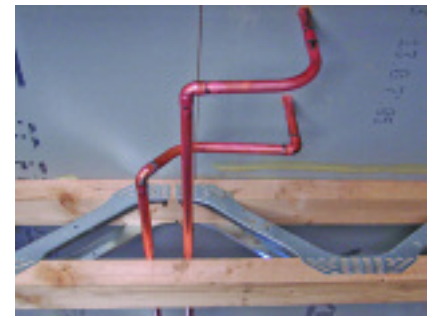

Separating floor construction: 60 minutes fire resistance

Span Tables

The following span tables are to be used as a basic guide to achievable joist span for given depth and spacing, and should be used for estimating or feasibility only.

Due to variations in timber grades, load sets, support conditions and bearing widths, the tables are not suitable as a design tool. Please consult an **easi-joists**® manufacturer for more information and design assistance.

Load and Span Description

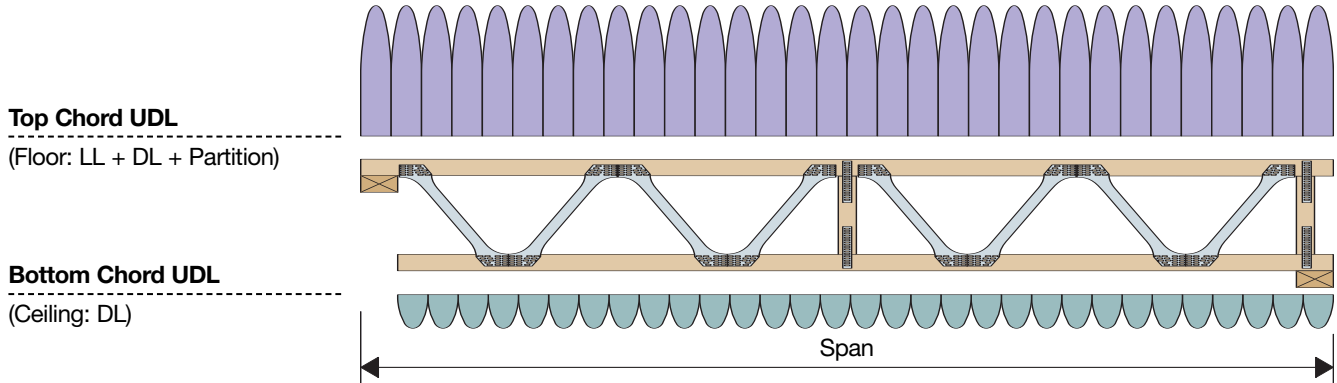

United Kingdom Span Table

WS200 easi-joist®			
Joist depth	Joist centres	Chord dimensions	Maximum permissible span
219	400	72 x 47	5125
		97 x 47	5450
		122 x 47	5725
	600	72 x 47	4525
		97 x 47	4850
		122 x 47	5075
WS250 easi-joist®			
Joist depth	Joist centres	Chord dimensions	Maximum permissible span
254	400	72 x 47	5550
		97 x 47	5900
		122 x 47	6200
	600	72 x 47	4950
		97 x 47	5250
		122 x 47	5475
WS300 easi-joist®			
Joist depth	Joist centres	Chord dimensions	Maximum permissible span
304	400	72 x 47	6075
		97 x 47	6475
		122 x 47	6775
	600	72 x 47	5425
		97 x 47	5475
		122 x 47	5500
WS400 easi-joist®			
Joist depth	Joist centres	Chord dimensions	Maximum permissible span
417	400	72 x 47	7125
		97 x 47	7575
		122 x 47	7925
	600	72 x 47	6100
		97 x 47	6125
		122 x 47	6145

Load Criteria

Spans are calculated based on the following applied floor loadings:

Top chord (live)	1500 N/m ²	
Top chord (dead)	210 N/m ²	
Top chord (partitions)	220 N/m ²	
Bottom chord (dead)	200 N/m ²	Total load 2130 N/m²

Support Conditions (SC)

There are four typical support conditions used in the design of **easi-joists**® which provide an important benefit in flexibility for connecting to different bearing members such as timber frame, masonry or steel. For more information on support conditions, see pages 22–27 of this manual.

The support conditions below are possible for varying methods of connection to timber frame or masonry walls, or connection to steel or timber beams.

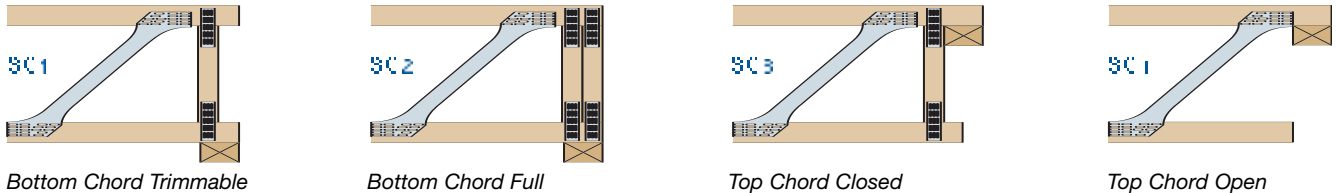

Republic of Ireland Span Table

WS200 easi-joist®			
Joist depth	Joist centres	Chord dimensions	Maximum permissible span
219	400	72 x 47	5125
		97 x 47	5475
		122 x 47	5600
	600	72 x 47	4550
		97 x 47	4900
		122 x 47	5125
WS250 easi-joist®			
Joist depth	Joist centres	Chord dimensions	Maximum permissible span
254	400	72 x 47	5550
		97 x 47	5925
		122 x 47	6225
	600	72 x 47	4975
		97 x 47	5300
		122 x 47	5325
WS300 easi-joist®			
Joist depth	Joist centres	Chord dimensions	Maximum permissible span
304	400	72 x 47	6100
		97 x 47	6500
		122 x 47	6825
	600	72 x 47	5275
		97 x 47	5295
		122 x 47	5310
WS400 easi-joist®			
Joist depth	Joist centres	Chord dimensions	Maximum permissible span
417	400	72 x 47	7125
		97 x 47	7550
		122 x 47	7925
	600	72 x 47	5850
		97 x 47	5870
		122 x 47	5875

Load Criteria

Spans are calculated based on the following applied floor loadings:

Top chord (live)	1500 N/m ²	
Top chord (dead)	210 N/m ²	
Top chord (partitions)	220 N/m ²	
Bottom chord (dead)	200 N/m ²	Total load 2130 N/m²

Notes for UK and Republic of Ireland Tables

1. Permissible spans assume 100mm wide supports at each end, with the permissible span being taken between the centre-lines of the supports.
2. Spans are based on deflections being limited to 0.003 x span up to a maximum of 14mm.
3. Joists are simply supported at each end, with a minimum bearing of 45mm.
4. Lateral restraint is provided by a suitably fixed floor deck, which will prevent buckling of the compression flange.
5. The joists are assumed to be part of a load-sharing system as defined in BS 5268-2, Clause 2.9.
6. Support conditions and web direction/orientation can affect the spanning capacity of a joist.
7. Spans given in the tables for UK and Ireland have been designed using support condition SC2 and are intended as a guide only.

Strongback Sizes and Installation

Strongbacks are an essential part of the floor construction as a whole. They provide essential damping qualities to the floor by connecting joists together to form a load sharing system that limits deflection and stiffens the floor. In addition it provides a useful form of lateral bracing within the floor during its construction (see pages 18, 23, 24 and 32 for further Strongback bracing details).

Fixing & Splicing

Correct installation of the Strongback and flooring material will ultimately determine how well the **easi-joist** floor system will perform. It is recommended that the Strongback be installed tight to the top chord of the **easi-joist** beam and should be twice nailed to the columns provided with 3.35 x 65mm wire nails. Strongbacks may be spliced where required by fixing a 600mm timber splice equally over the joint, and nailed using 6 no 3.35 x 65mm nails on either side of the joint.

IMPORTANT

The correct fixing of the Strongback is essential to overall floor performance and must be carried out as instructed above. Fixing the Strongback by screwing is also satisfactory.

Deflection Limits

When Strongbacks are used, **easi-joist** beams have a maximum deflection limit of 14mm or span x 0.003, whichever is least. If Strongbacks are not provided NHBC Standards 6.4-D4 (a) stipulates a maximum 12mm deflection limit. NHBC requires that Strongbacks are to be used and located according to the following rules:

- Spans less than 4.0m = Strongback not required
- Spans between 4.0m and 8.0m = 1 Strongback at centre of span
- Spans greater than 8.0m = 2 Strongbacks at equal spacing

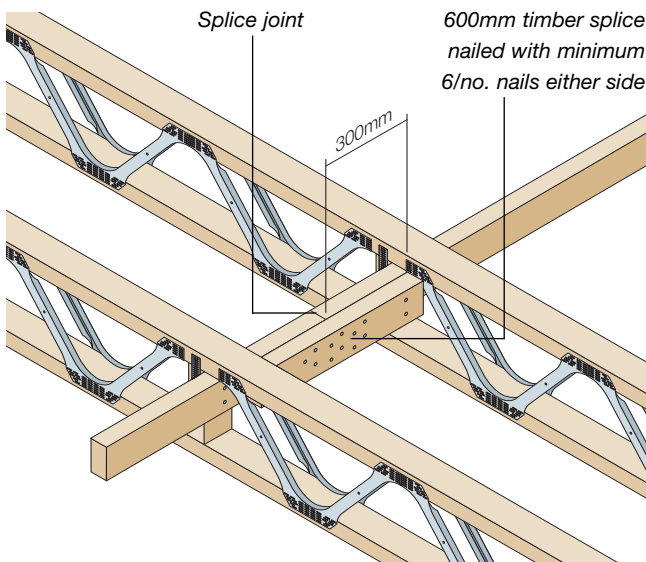

Horizontal Restraint Strap

Horizontal bracing straps are required to be fixed to loadbearing walls perpendicular to **easi-joists**. This member must be continuous over a minimum of 3 **easi-joists**.

Straps to be fixed in strict accordance with manufacturer's instructions.

35/47 x 97mm twice nailed to brace using 3.35 x 65mm long galvanised nails

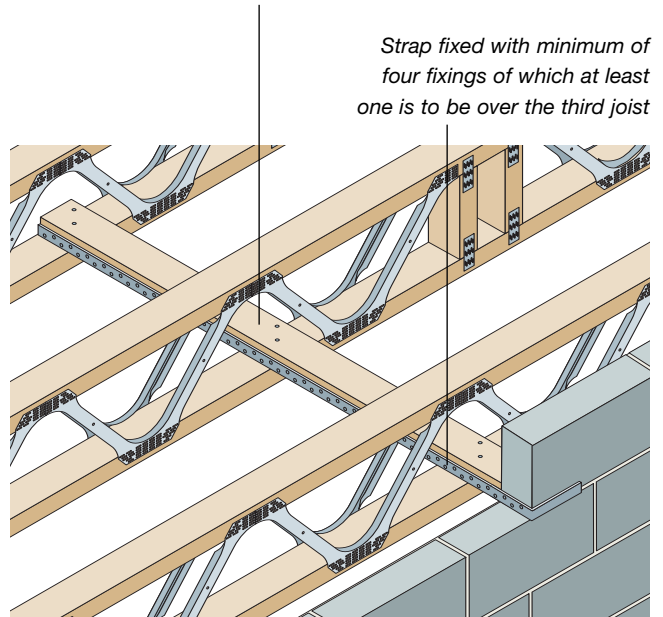

easi-joist® Nominal Size	Strongback size TR26 Grade	Alternate Strongback Lower Grade
WS200	35 x 72 TR26	35 x 97 C16
WS250	35 x 97 TR26	35 x 122 C16
WS300	35 x 122 TR26	35 x 142 C16
WS400	35 x 147 TR26	35 x 172 C16

Suspended Ground Floors

When designing and installing **easi-joists**® at ground floor level, the following points should be considered.

Ground floor suspended floors are classified as Service Class 2 and therefore will have an increased moisture content.

Adequate provision should be made for ventilation of the void below the joists which must be maintained at a minimum of 150mm deep and comply with Building Regulations.

The absence of a ceiling covering results in the bottom chord of the **easi-joist**® having no lateral restraint. Therefore noggins must be installed along intermediate supports to prevent buckling where the bottom chord will be in compression.

Deflection limits may be reduced to account for the reduced stiffness of the floor compared to floors fitted with a ceiling diaphragm.

Large appliances such as washing machines or spin dryers may produce dynamic movement requiring more stringent deflection limits.

Induced dynamic movement will be reduced by using a discontinuous joist layout between separate ground floor rooms.

British Standard Service Classes

- Service Class 1
Internal use in continuously heated building, 12% moisture content
- Service Class 2
Covered and generally heated, 15% moisture content
- Service Class 2
Covered and generally unheated, 18% moisture content
- Service Class 3
External use, fully exposed, more than 20% moisture content

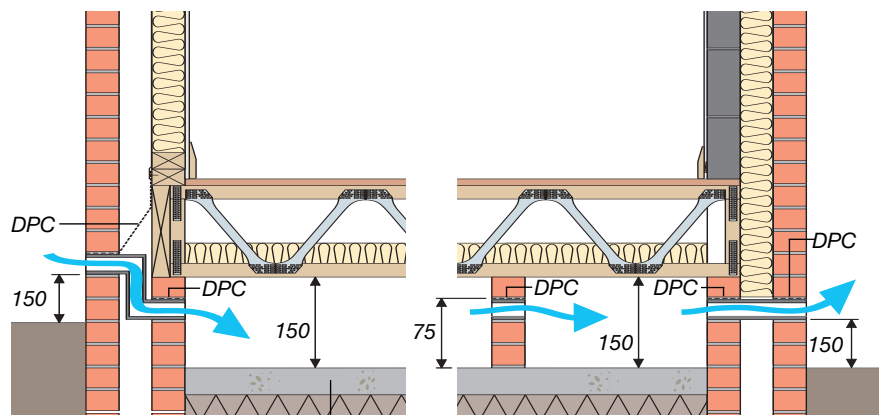

Internal ground covering to comply with Building Regulations

Note: Dimensions (mm) are minimum requirements

Typical **easi-joist**® ground floor detail

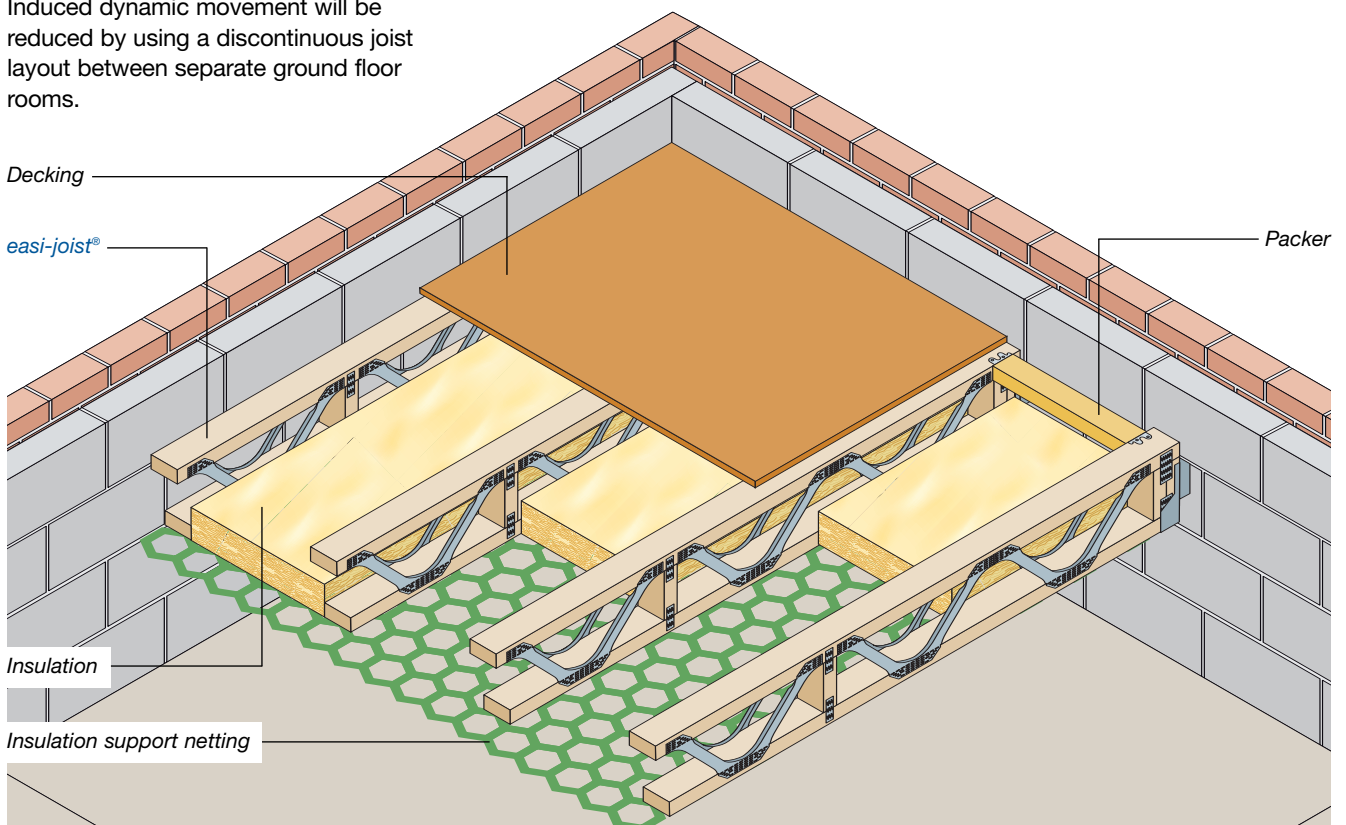

Loading

Dead loads

Dead load should account for all building materials in the floor structure including ceiling linings and insulation. This should also include non-load bearing partition walls which have not been accounted for with line loads.

The minimum dead load for single occupancy domestic floors including the floor deck, self-weight of joists and plasterboard, but excluding any allowance for non-load bearing partitions should be a minimum of 0.41 kN/m².

Imposed loads

Imposed or “live” loads are generated by the intended use and occupancy of the floor generated by moveable partitions and domestic storage, concentrated, impact and inertia loads.

Imposed loads are the loads produced by the occupancy of a building including storage and inhabitants. The imposed floor load compatible with the building usage should be obtained from BS 6399-1 and BS EN 1991-1-1. Typical imposed uniformly distributed floor loads are shown on page 19.

Additional loads

Care should be taken to ensure additional loads are considered within the design of *easi-joists*[®]. Examples of additional loads are snooker tables, load bearing walls, access hoists, home multi-gyms, spa baths, water storage cylinders and chandeliers.

Each of these examples will require region, line or points loads to be additionally applied to the floor design. The list is not exhaustive and advice should be sought if in doubt regarding additional loads.

Partition loads

It is the guidance of the EWP code of practice that loading which allows for the self-weight of non-load bearing partitions shall always be applied to the design of domestic floors using *easi-joists*[®], irrespective of whether non-load bearing partitions are present on the floor.

The self-weight of partitions should be accounted for by applying loads in accordance with the following:

- Where the location of partitions are known, joists should be designed for the most onerous of the following:
 - a minimum line load at partition locations of 0.64 kN/m²
 - a minimum uniform load of 0.22 kN/m².
- Where the location of partitions are not known, joists should be designed for a minimum load of 0.22kN/m².

The minimum partition load of 0.64 kN/m² is applicable for partitions weighing up to 27 kg/m².

Stair loads

Wherever stairs are fixed to *easi-joists*[®] the dead and imposed load from the stairs should always be applied to the floor.

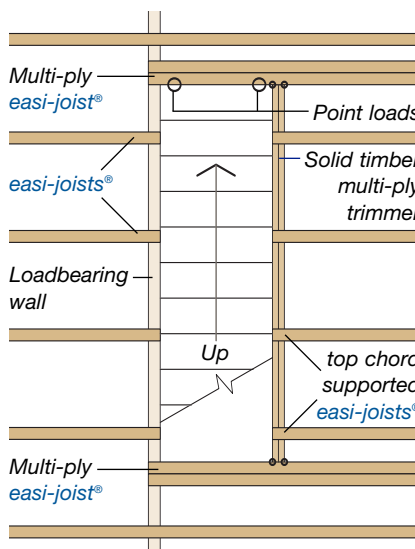

Stair arrangement

Weights of building materials

Asphalt roofing	per layer	206 N/m ²
Chipboard	18mm	140 N/m ²
Chipboard	22mm	175 N/m ²
Plasterboard	9.5mm	81 N/m ²
Plasterboard	12.5mm	110 N/m ²
Plasterboard	15mm	131 N/m ²
Plasterboard	19.1mm	187 N/m ²
Plywood	12mm	82 N/m ²
Plywood	15mm	103 N/m ²
Plywood	18mm	124 N/m ²
Fibreglass insul	100mm	40 N/m ²
Joist self-weight	600mm c/c	125 N/m ²

Stiffness

The dynamic action of any floor system is dependent on the floor geometry, the applied loads and the level of expectation of the occupants.

Damping

Components can be added to the building structure which act to reduce vibration and deflection of the floor. This is known as damping.

An important contributor to the damping effect is the Strongback, a solid timber member running perpendicular to the joists usually fixed to the underside of the joists' top chord. By providing a solid connection between adjacent joists, the movement of any individual joist is reduced.

The improvements to the floor gained by the installation of a Strongback are dependent on its correct size, position and fixture to the *easi-joist*[®].

Strongbacks are generally provided at the centre of any span greater than 4m.

Other floor damping components include internal walls, resilient battens and floor or ceiling coverings screwed directly to the joists. Damping is achieved by reducing the effective area or by restraining the dynamic action of the floor.

See page 9 for more details on Strongbacks.

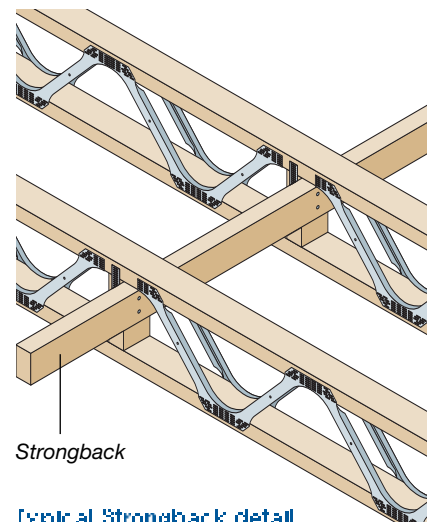

Typical Strongback detail

Typical minimum imposed uniformly distributed floor loads

This table presents a summary of the most common imposed loads taken from the full list given in the codes of practice BS 6399-1 and BS EN 1991-1-1.

Type of occupancy	Examples of specific use	Uniformly distributed load (kN/m ²)	
		BS 6399-1	BS EN 1991-1-1
A: Domestic and residential	1. All usages within self-contained dwelling units and communal areas (including kitchens) in blocks of flats with limited use ^(1,2)	1.5	1.5
	2. Bedrooms and dormitories except those in hotels and motels	1.5	1.5
	3. Bedrooms in hotels and motels Hospital wards Toilet areas	2.0	2.0
	4. Billiard rooms	2.0	2.0
	5. Communal kitchens except in flats covered by 1 above	3.0	3.0
B: Offices and work areas ⁽³⁾	6. Operating theatres, x-ray rooms, utility rooms	2.0	2.0
	7. Work rooms (light industrial) without storage	2.5	2.5
	8. Offices for general use	2.5	2.5
	9. Banking halls	3.0	3.0
	10. Kitchens, laundries, laboratories	3.0	3.0
	11. Rooms with mainframe computers or similar equipment	3.5	3.5
	12. Machinery halls	4.0	4.0
	13. Projection rooms	5.0	5.0
C: Areas where people may congregate	14. Factories, workshops (general industrial)	5.0	5.0
C1: Areas with tables	15. Public, institutional and communal dining rooms ⁽³⁾ , lounges, cafes and restaurants	2.0	2.0
	16. Reading rooms with no book storages	2.5	2.5
Areas without obstacles for moving people	17. Classrooms	3.0	3.0
	18. Corridors, hallways, aisles, stairs, landings, etc. in institutional type buildings (not subject to crowds or wheeled vehicles), hostels, guest houses, residential clubs, and communal areas in blocks of flats not covered by 1 above	3.0	3.0
	19. Corridors, hallways, aisles, stairs, landings, etc. in all other buildings including hotels, motels and institutional	Foot traffic 4.0 Wheeled trolleys 5.0	Foot traffic 4.0 Wheeled trolleys 5.0

Notes

- 1 Communal areas in blocks of flats with limited use refers to blocks of flats of not more than three storeys and with not more than four self-contained dwelling units per storey accessible from one staircase.
- 2 For communal area in other blocks of flats see C3.
- 3 Where a dining room may also serve as an area for dancing refer to BS 6399-1 and BS EN 1991-1-1.
- 4 Imposed loads for storage areas within buildings of this occupancy type should be obtained from BS 6399-1 or BS EN 1991-1-1.

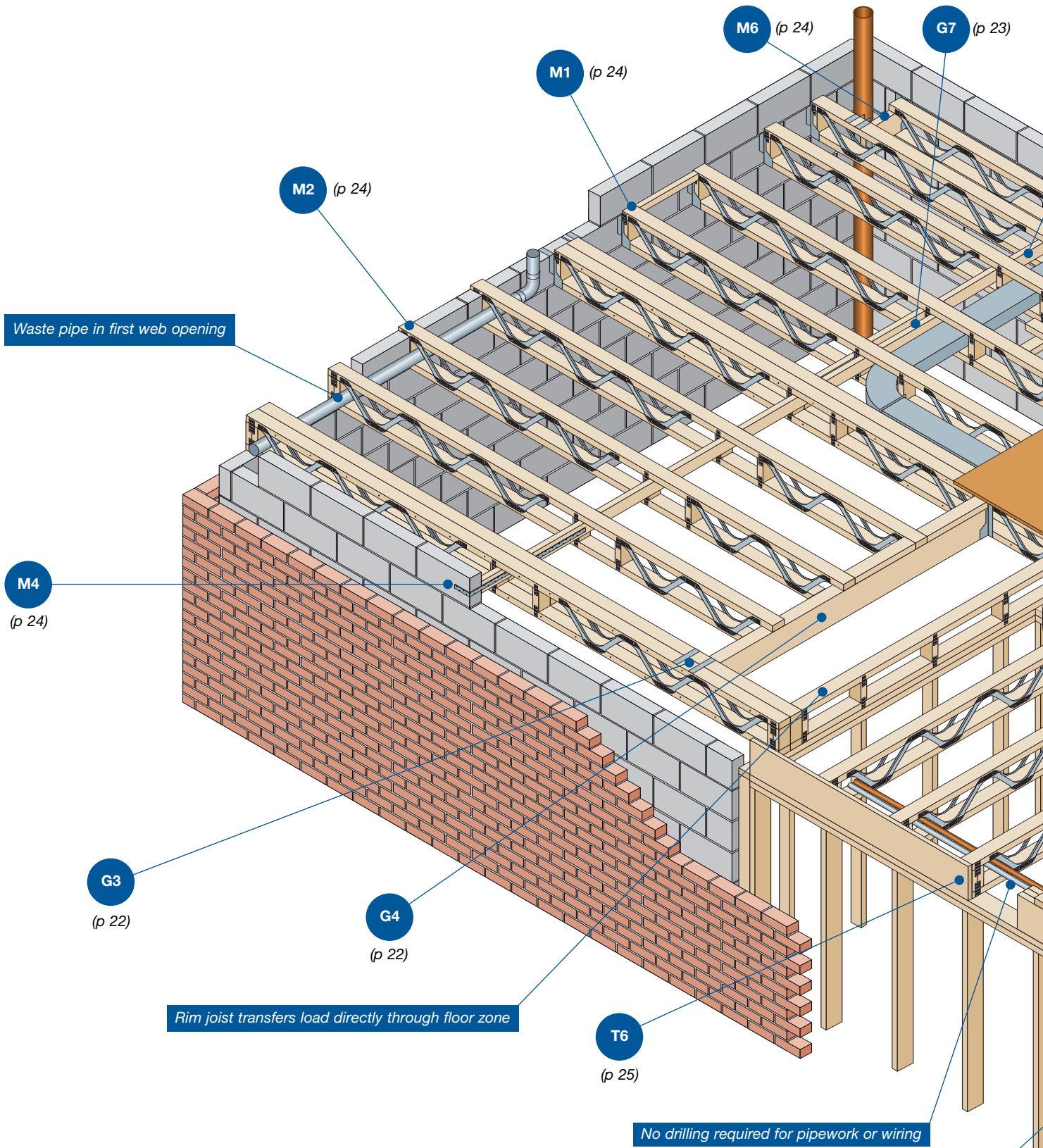

Details on the pages following are grouped into:

- General Floor Detailing: Details G1 to G12 (pp 22-23)
- Floor Detailing in Masonry Construction: Details M1 to M6 (p 24)
- Floor Detailing in Timber Frame Construction: Details T1 to T17 (pp 25-27)

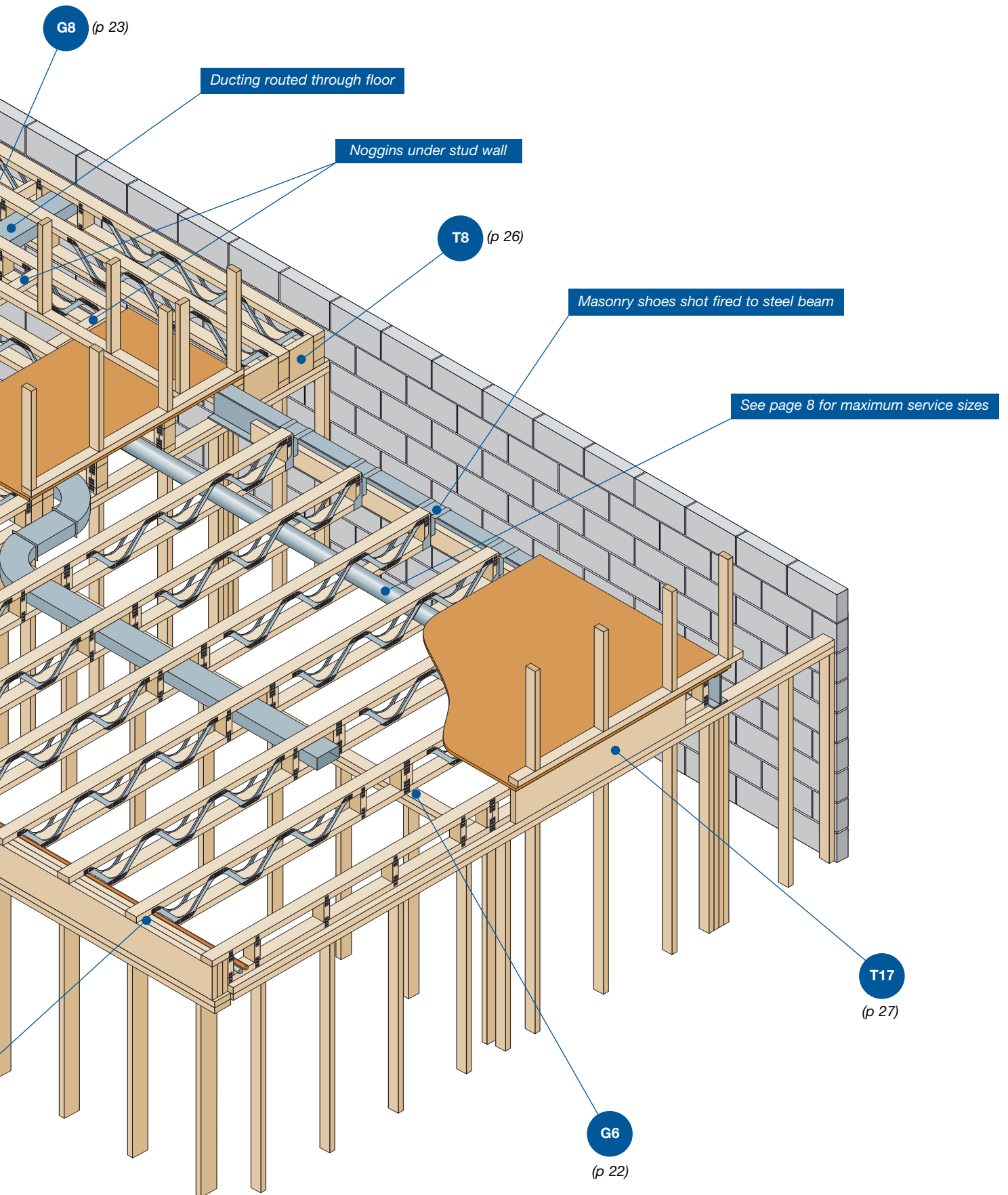

G1 • Face Fix Hanger

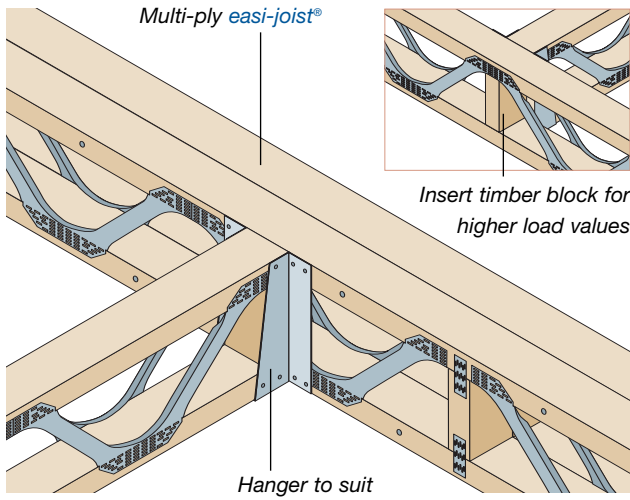

G2 • Strap Hanger

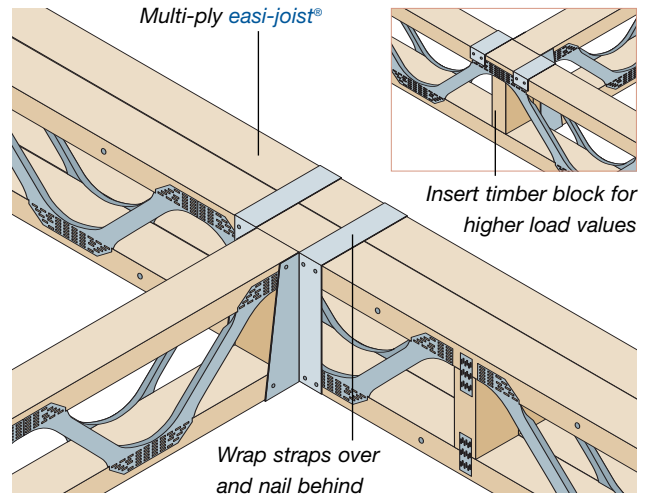

G3 • Stair Opening with easi-joist®

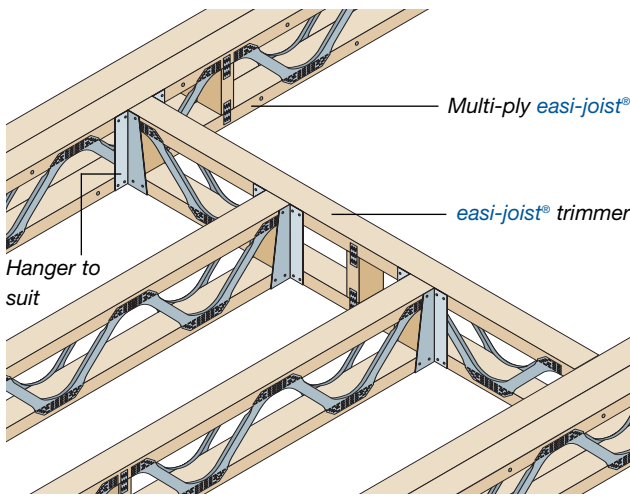

G4 • Stair Opening with Binder

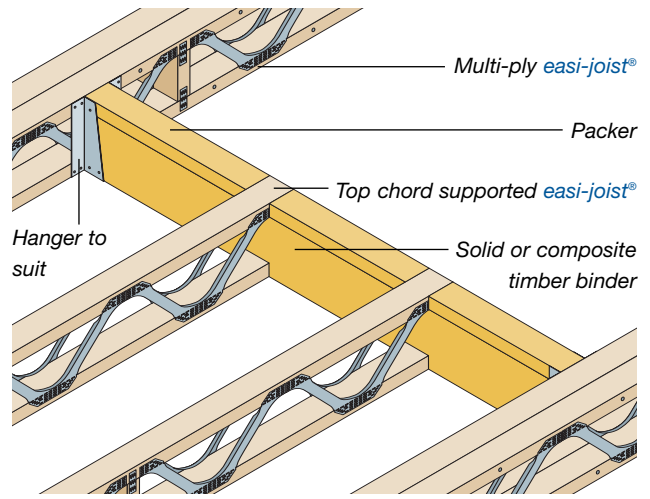

G5 • Intermediate Support (on to block wall)

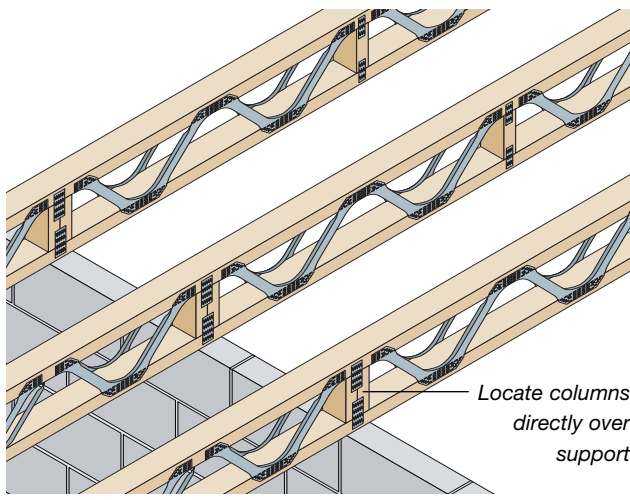

G6 • Intermediate Support (on to stud wall)

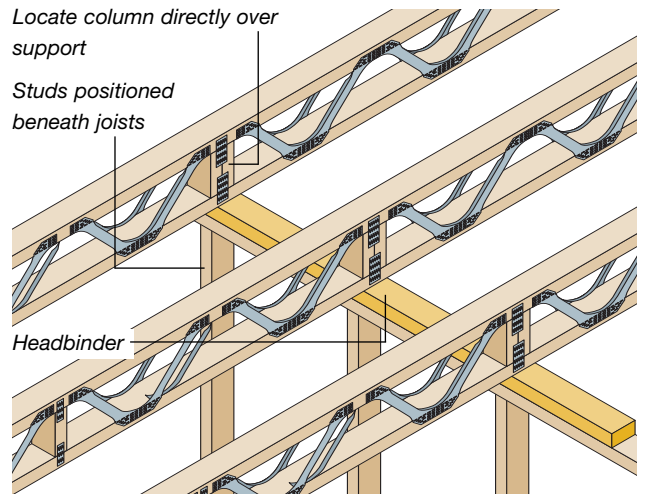

G7 • Strongback Lapping

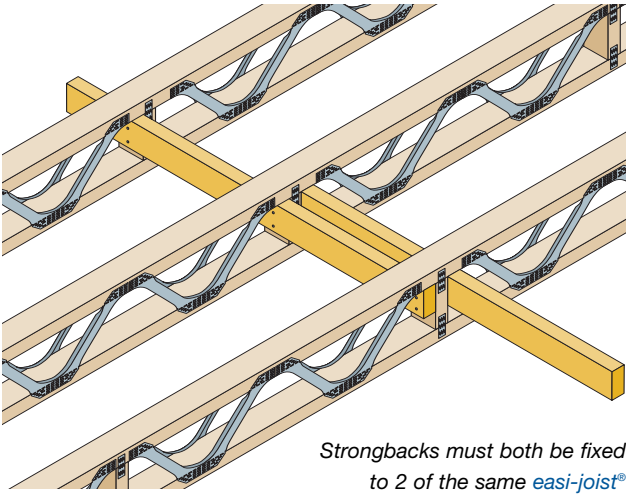

G8 • Strongback

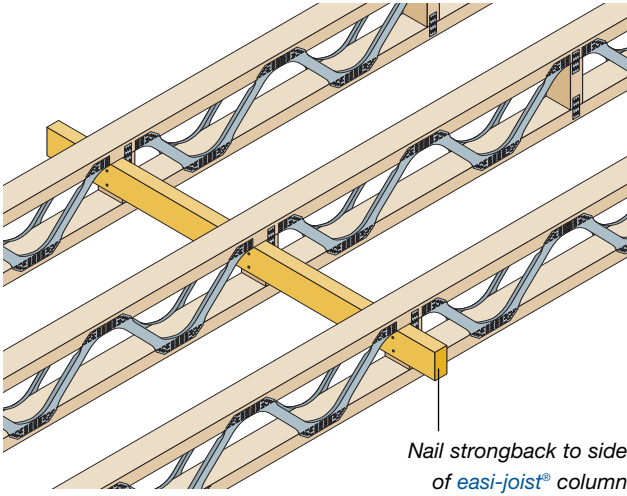

G9 • Strongback Splice

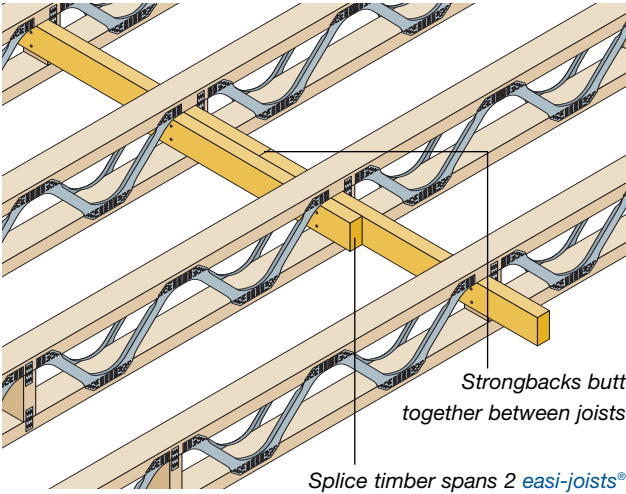

G10 • Top Chord Support on to Steel

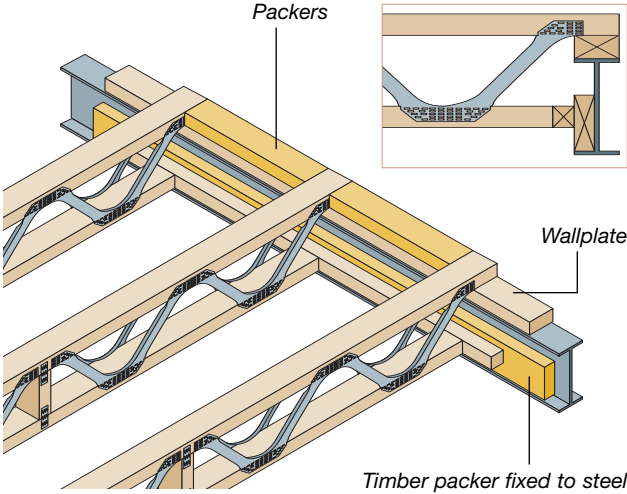

G11 • Joist on I-Beam with Hidden Support

Hidden top chord support allows for continuous ceiling material

It is the responsibility of the designer to check the design of the joist to ensure the bottom chord can be cut to allow access to the beam

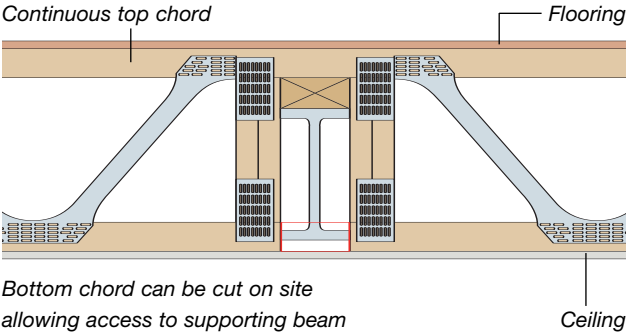

G12 • Cantilevered Joists

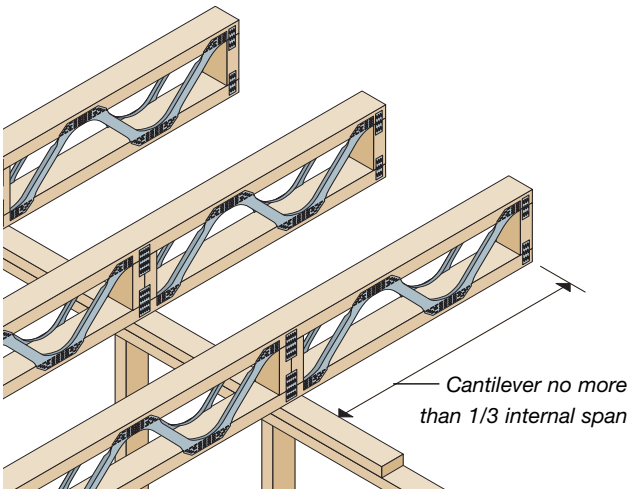

M1 • Hangers with Noggins

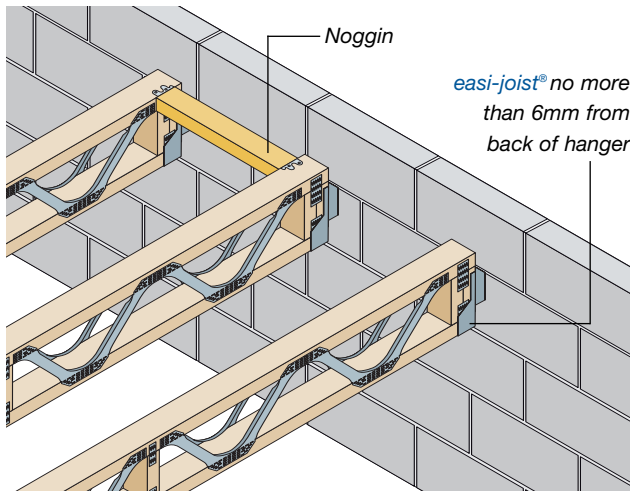

M2 • Bottom Chord Support Built In

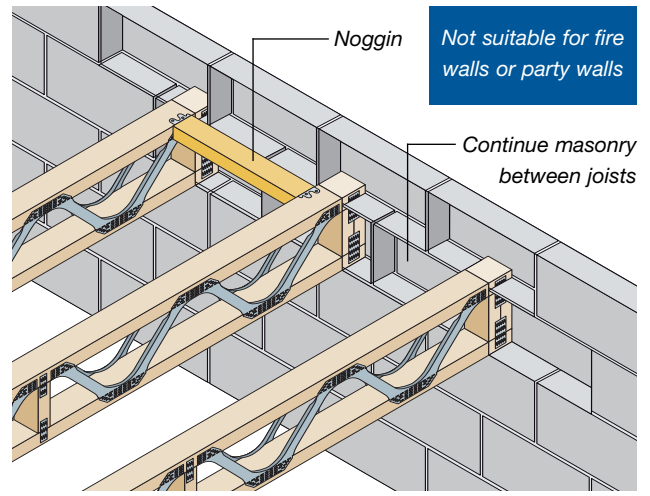

M3 • Top Chord Support Built In

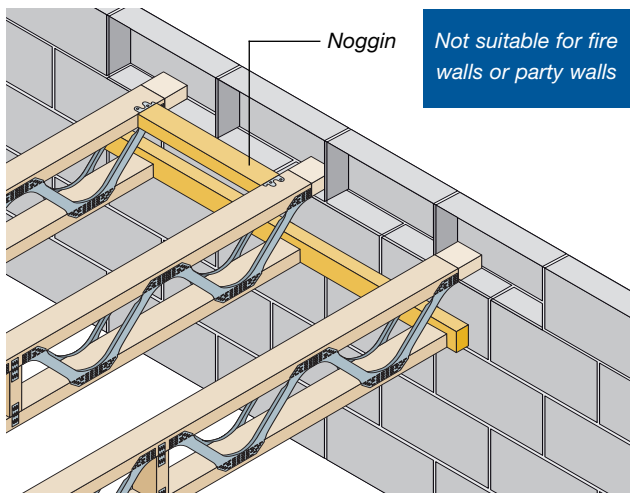

M4 • Lateral Restraint of Strongback

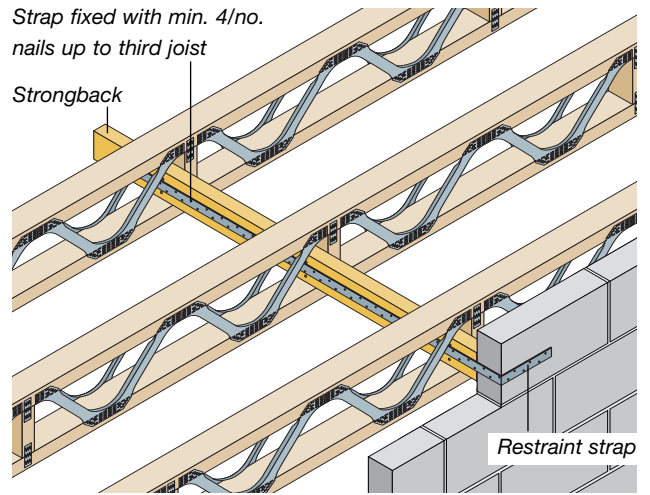

M5 • Lateral Restraint Bracing

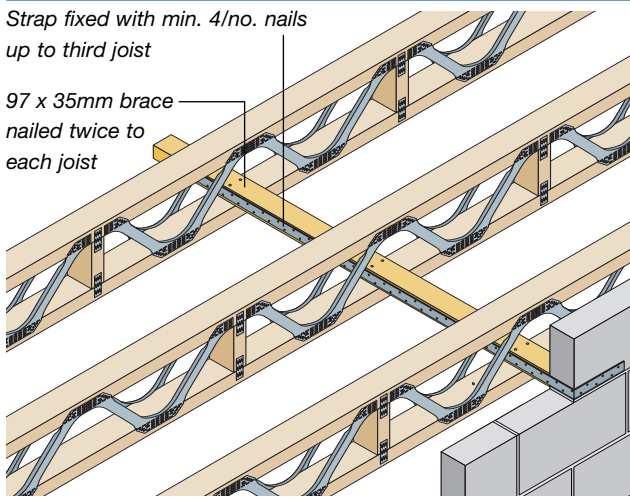

M6 • SVP with Trimmer

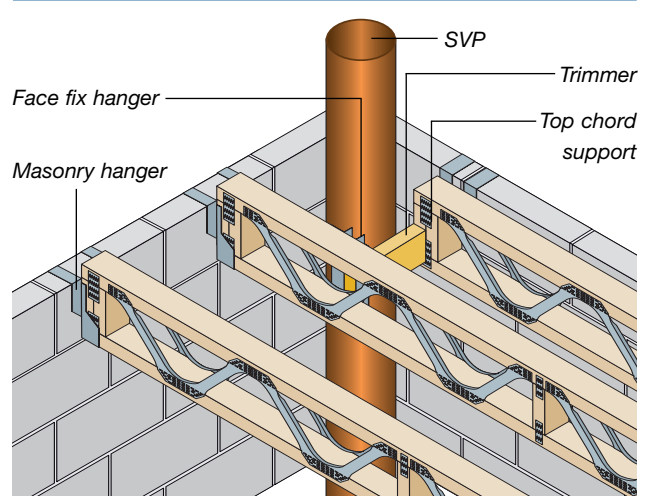

T1 • Internal Wall Lapped Joists

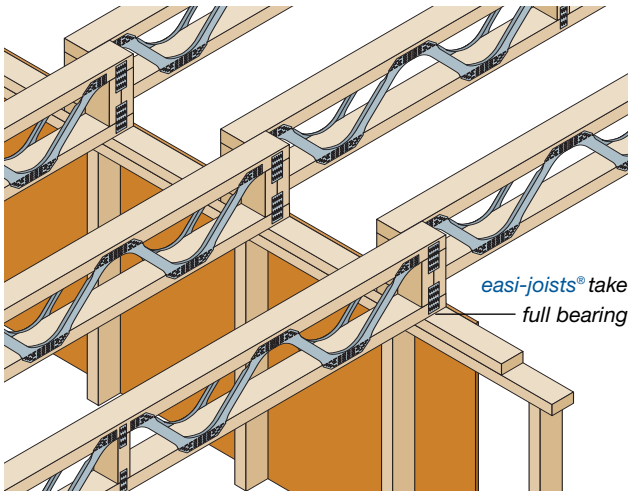

T2 • Internal Wall Butted Joists

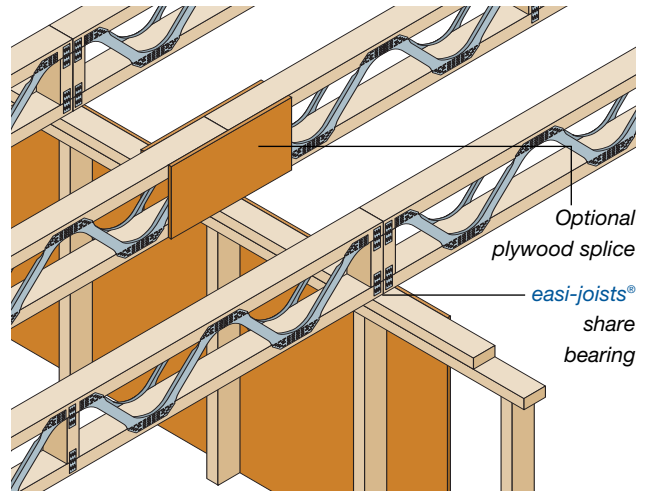

T3 • Intermediate Support (on to stud wall)

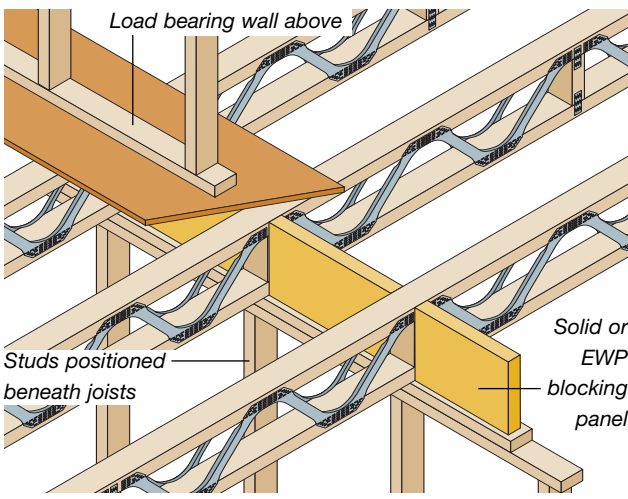

T4 • Intermediate Support (on to stud wall)

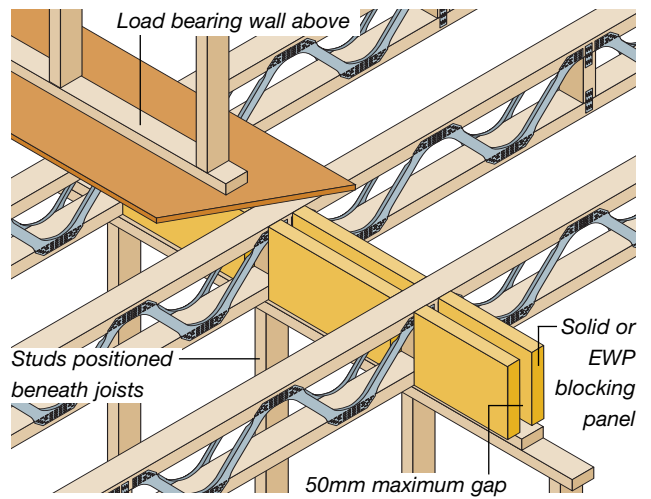

T5 • Bottom Chord Support with Trimmable End and Rim Board

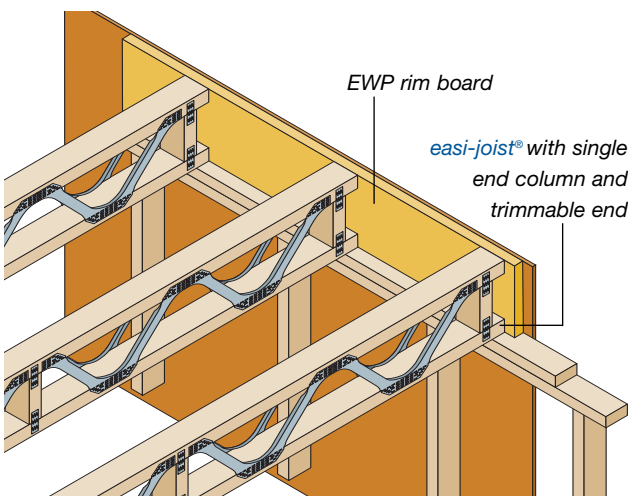

T6 • Bottom Chord Support with Rim Board Closure

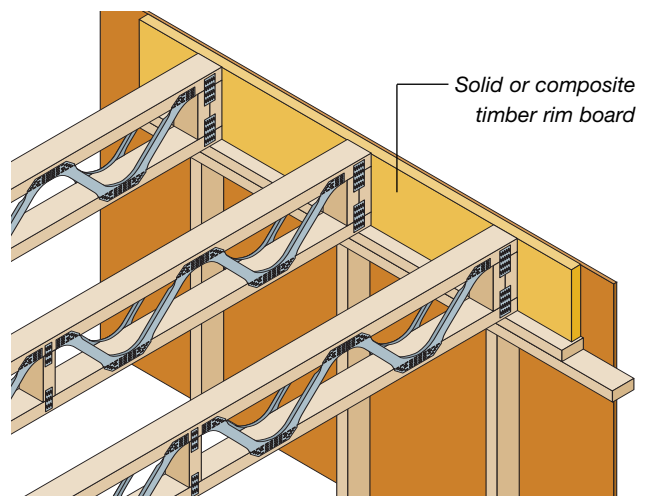

T7 • Bottom Chord Support with Restraint Noggins

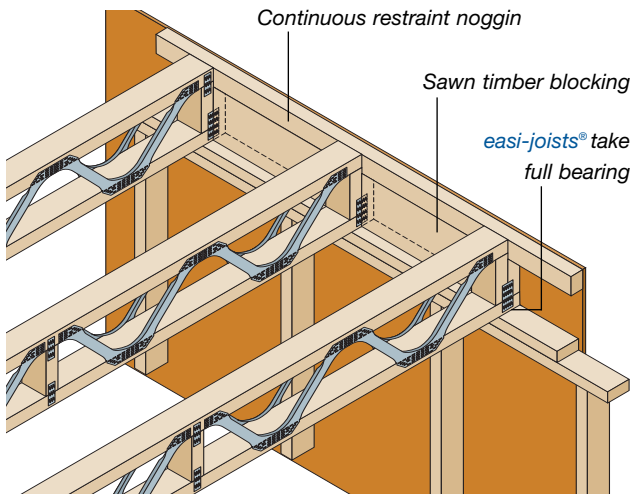

T8 • Bottom Chord Support with Full Height Blocking

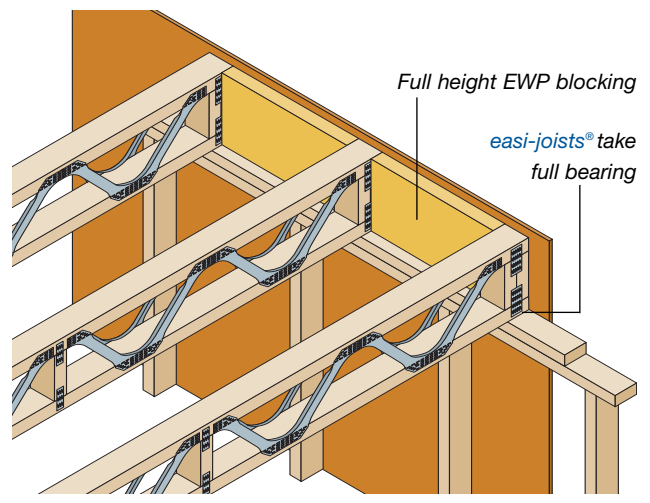

T9 • Top Chord Support

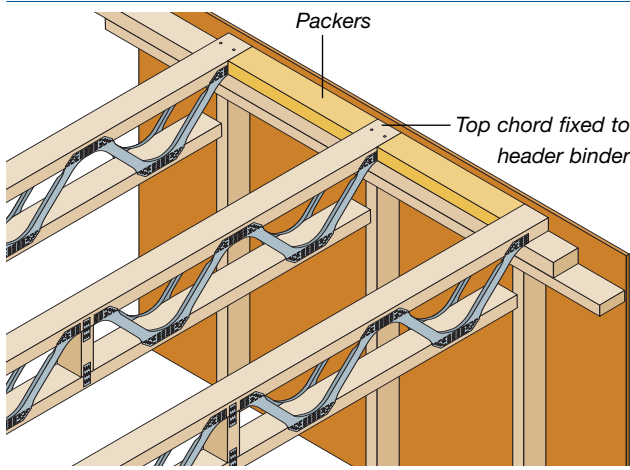

T10 • Top Chord Support with End Column

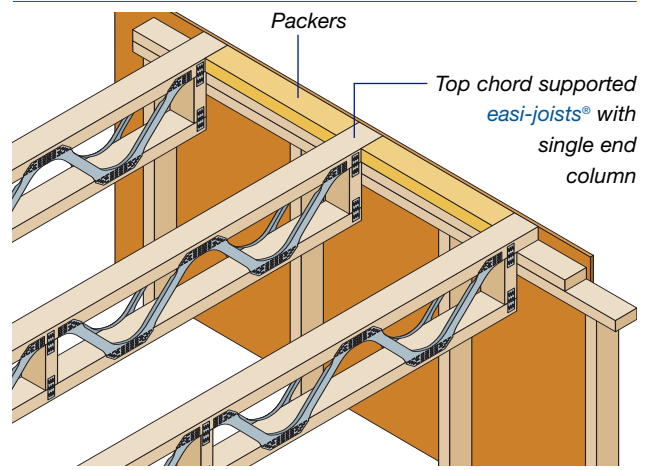

T11 • Bottom and Top Chord Support with EWP Rim Board

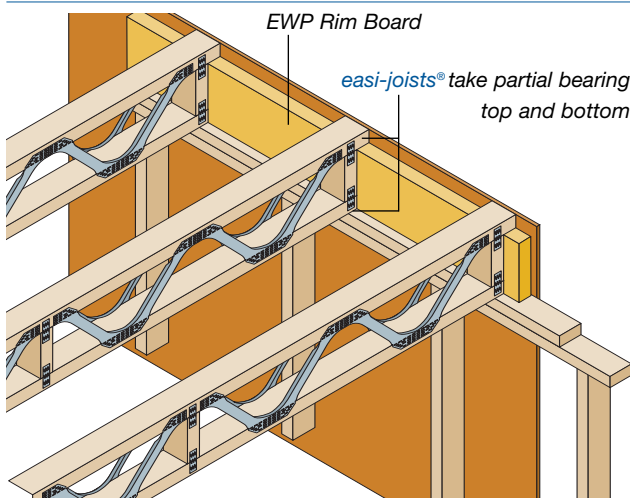

T12 • Top Chord Support with Double Rim Board

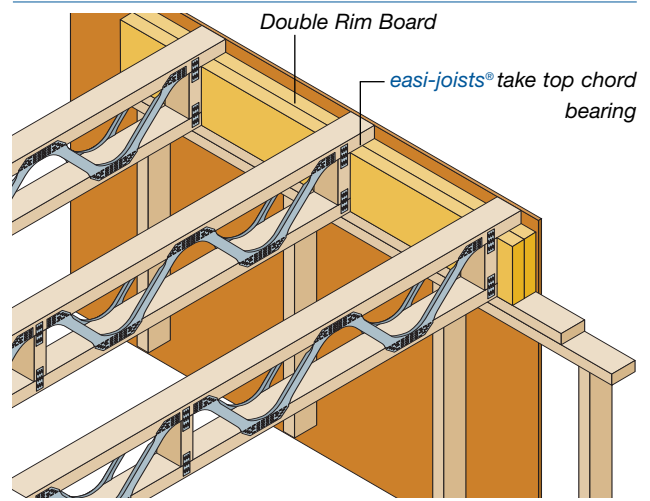

T13 • Top Chord Support on Ring Beam

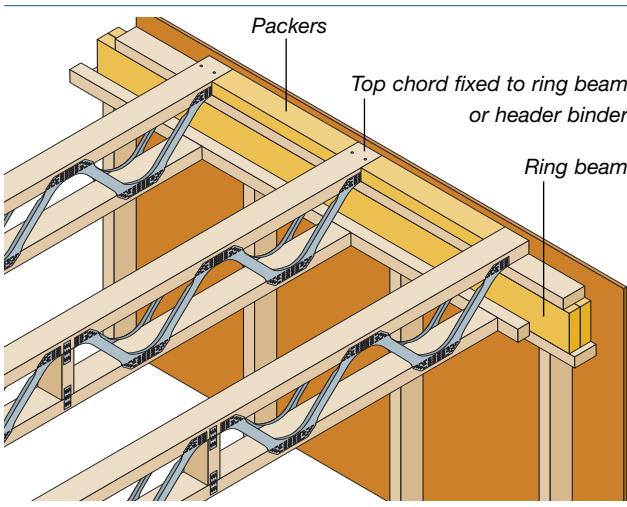

T14 • Proposed Arrangement for Timber Frame Construction

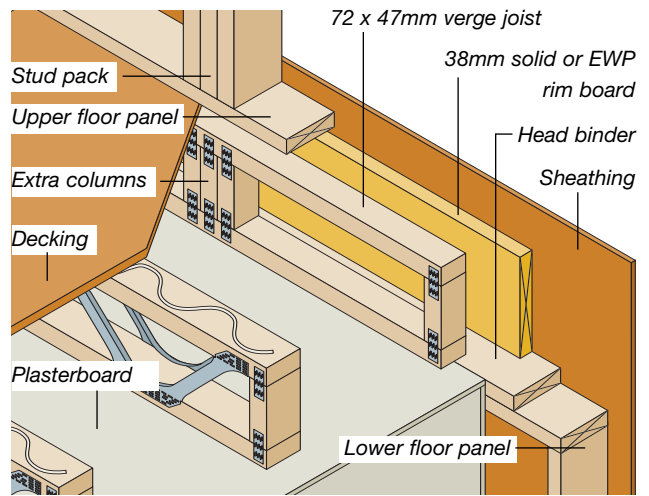

T15 • Proposed Arrangement for Timber Frame Construction

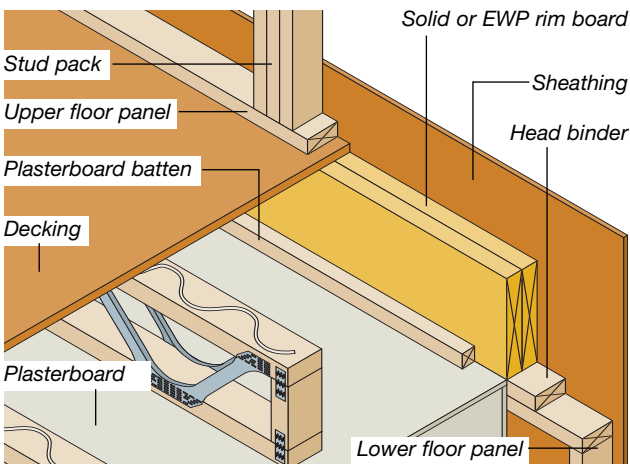

T16 • General Arrangement for Timber Frame Construction

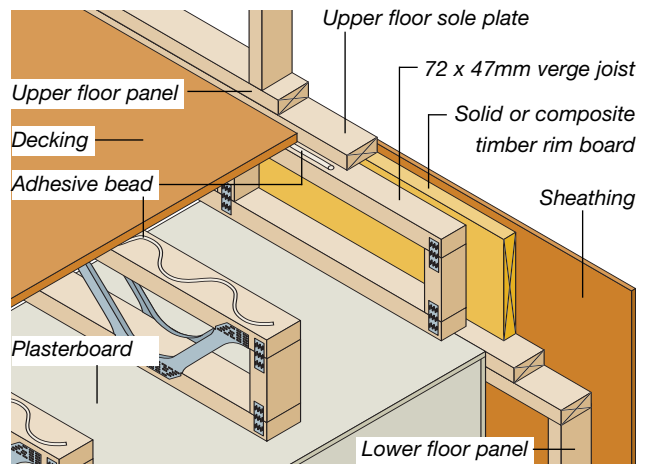

T17 • Proposed Arrangement for Timber Frame Construction

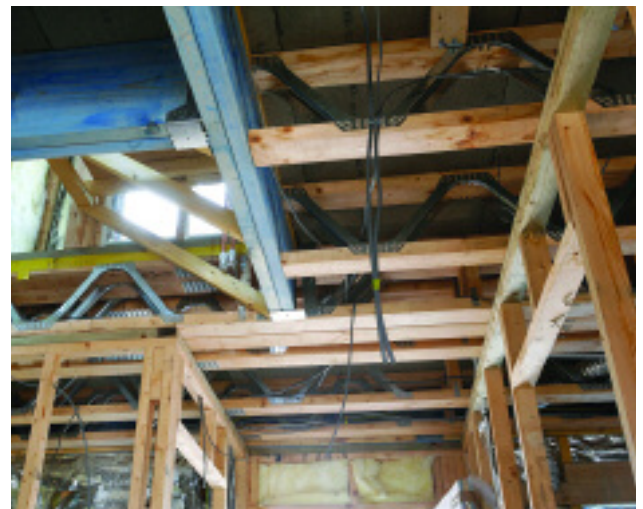
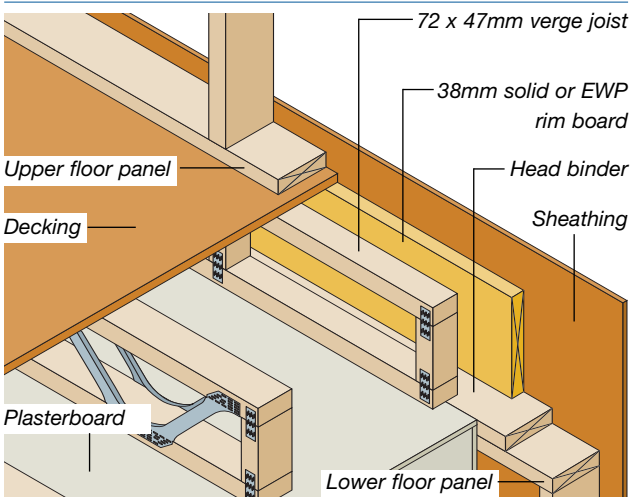

Introduction

Metalwork items required for **easi-joist'** floor systems can be obtained from either Cullen Building Products or Simpson Strong-Tie and are available in a variety of sizes to suit the entire **easi-joist'** range.

Timber Hangers

There are two main types of timber to timber connection associated with **easi-joist'** floors – trimmers supporting onto easi-joists and trimmers supporting onto solid timbers. In both cases a trimmer itself could be either solid timber or **easi-joist'**.

Cullen UW / HW or Simpson IUB / HIUB:

Both ranges are designed specifically for **easi-joist'** to **easi-joist'** connections but can also accommodate solid or composite timber as supported items. Hangers are designed to suit the specific depth of the supporting **easi-joist'** and have nail or screw holes aligned with both top and bottom timber flanges.

Cullen KH / MHE range or Simpson JHA / SAE range:

Joist hangers designed for solid timber to timber connections which can also accommodate **easi-joists'** as supported items. KH and JHA strap hangers are versatile but have limited flange depth making them unsuitable for deeper joists. MHE and SAE face fix hangers offer higher safe working loads.

Restraint strap

Provides lateral restraint to the floor system by creating a positive connection between joists and parallel end walls. The strap is made from 1.5mm galvanised steel 1.5m long and is fixed in place with 3.75 dia. x 30mm square twist nails. Straps should be fitted at a maximum of 2m spacing between joist support positions.

Additional parallel restraint straps (as shown in photograph) are also required every 2m unless the masonry shoes provide restraint

Masonry Hangers (Cullen JHIR range or Simpson JHM range)

Hangers are required to bear directly onto masonry with a minimum crush strength of 3.5N/mm² which should be extended to a minimum of 675mm (3 block courses) above the hanger and allowed to cure before loads are applied.

The supported joist should finish no greater than 6mm away from the face of the hanger. Masonry hangers may also be shot fired onto steel beams.

Z Clips

Double angled brackets which quickly and securely locate and fix noggins to top or bottom flanges without need to stagger the noggins. Primarily used for perimeter noggins or for noggins supporting walls running parallel to joists.

Joist Girder Screws (Cullen Timberlok or Simpson SDS)

These are self-tapping coach screws with a hexagonal head available in a variety of lengths.

Drive into top and bottom chords at maximum 600mm centres to fix joists into a multi-ply girder.

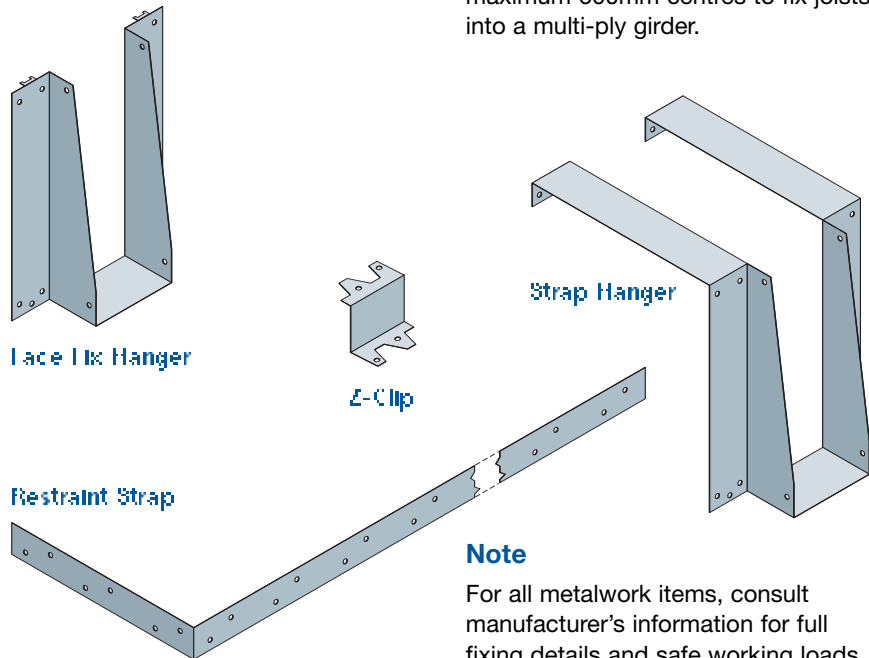

Note

For all metalwork items, consult manufacturer's information for full fixing details and safe working loads.

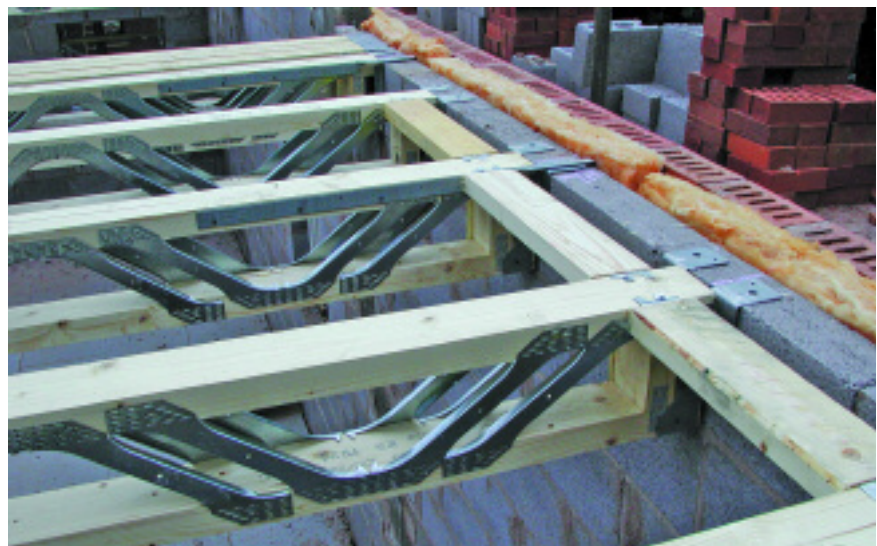

Introduction

easi-joists' can easily be adapted to create pitched roof structures as a lighter, more insulating alternative to solid sawn timber. By redesigning the end column configuration, the **easi-joist'** system can be installed onto a wallplate or ridge beam without the need for a bevelled wallplate or special metalwork item. This versatile connection detail enables top and bottom supports to accommodate a range of bearing widths and can also incorporate intermediate supports.

Using joists for roof structures requires considering external loading factors and more complex geometry at eaves and ridges.

Loading

Dead load should account for all building materials in the roof structure including ceiling linings and insulation.

Deflection is limited by BS 5268 to 0.003 times the span.

For roofs with pitch less than 30°, a man point load check (900 N) should be applied to the centre of any span as a short term load assuming no imposed loading. For steeper pitches, the load is assumed to be spread by a roof ladder.

Snow

Flat roof

Imposed (snow) load should be a minimum of 750 N/m² depending on geographical location.

Pitched roof

Imposed (snow) load should be maximum of 750 N/m² until 30° pitch whereupon it drops linearly to zero at 60° pitch.

In order to calculate dead load, refer to BS 648 Weights of Building Materials or the roof covering manufacturer's literature.

Wind

If a structural engineer identifies that the roof covering is not sufficient to resist wind uplift (usually in the case of light roof coverings at high elevations with low pitches) then further measures must be taken to vertically restrain the joists to the wallplate. For example, restraint straps may be used to anchor the roof structure to the masonry.

Bracing:

easi-joist' roofs should be temporarily braced longitudinally and diagonally during erection.

Structural sarking is the preferred method of providing racking resistance for the roof structure, however longitudinal and diagonal bracing can also be used.

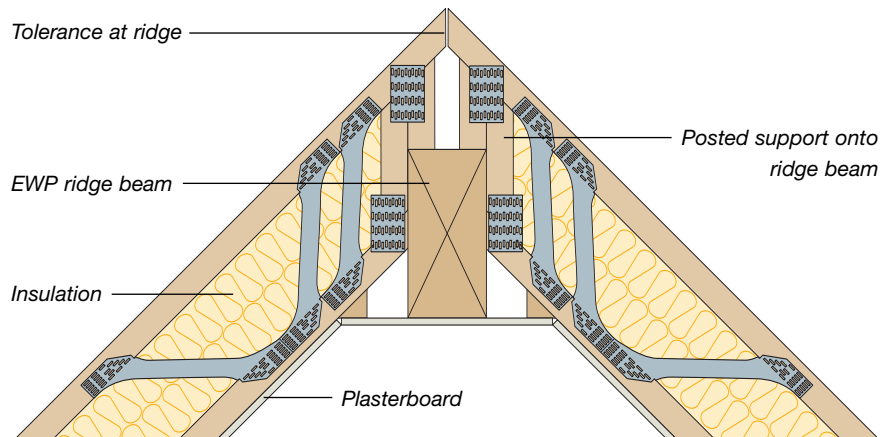

Ridge detail

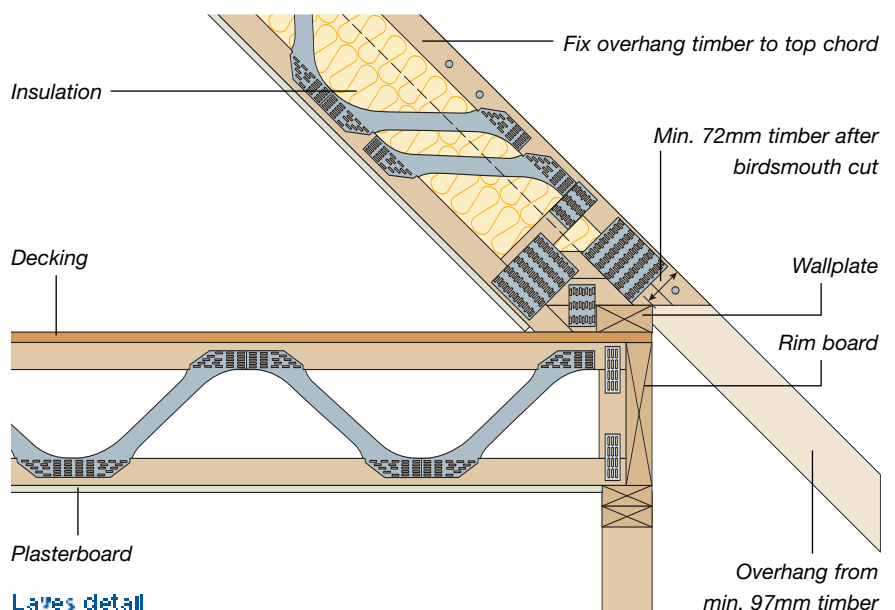

Eaves detail



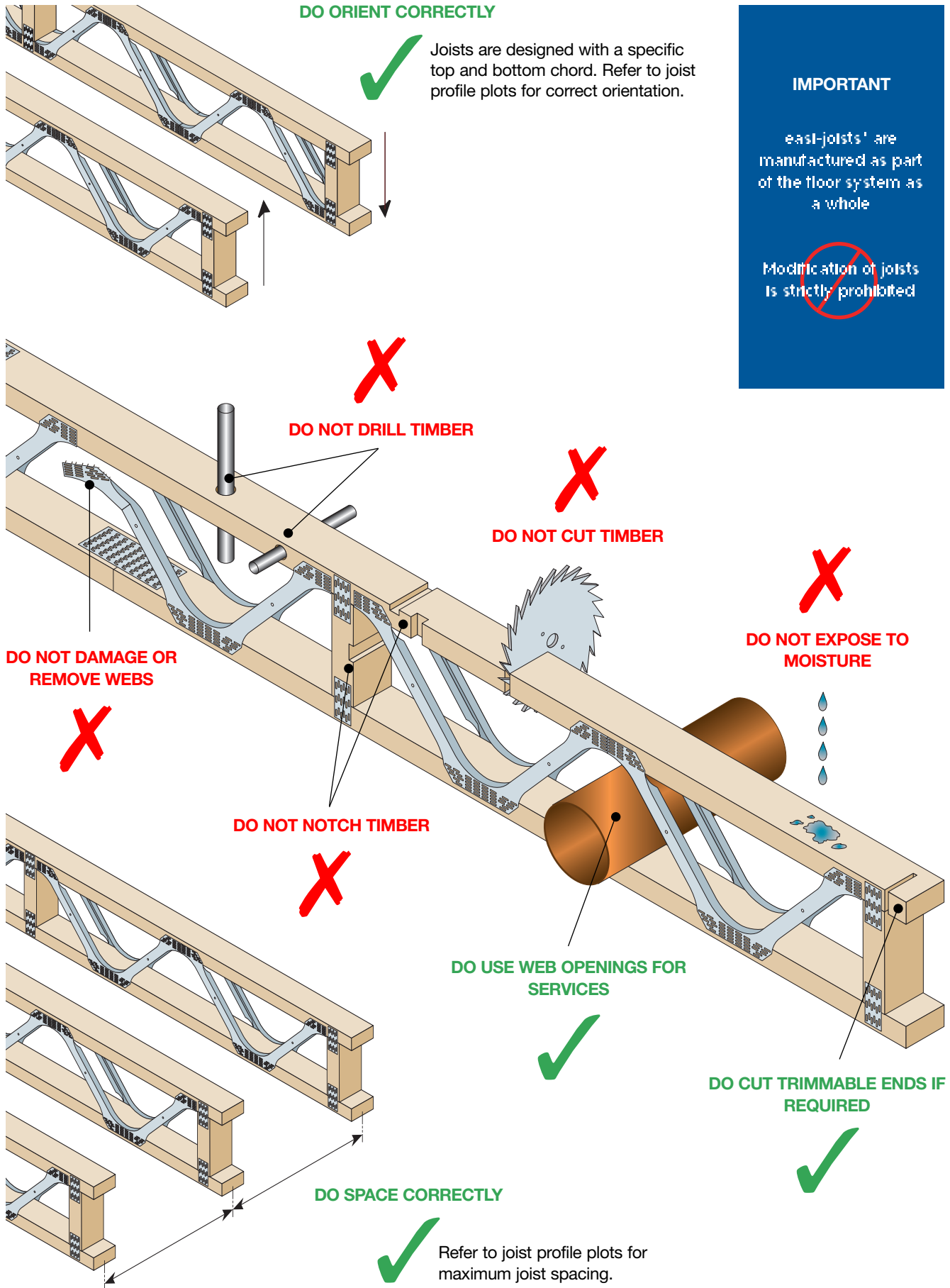

Handling:

- The site manager or contractor will be responsible for the handling of **easi-joists** from the time of unloading the delivery.
- Avoid dropping, twisting or subjecting **easi-joists** to heavy impact.
- Always lift **easi-joists** in the upright position to prevent lateral distortion.
- Use a fabric sling for lifting joists and ensure even weight distribution.

Storage:

- Storage time of **easi-joists** prior to installation should be kept to a minimum.
- **easi-joists** should be left in bundles and remain in packaging until use.
- During such time, joists should be kept dry, and laid horizontally in an upright position, clear from the ground. Bearers should be used underneath web or column joints to prevent distortion.
- Joists are unstable until fully braced or boarded. Do not walk or store materials on an unrestrained floor area.
- Sheet materials stacked on the **easi-joist** floor should not exceed 250mm in height or 250kg/m² (150kg per joist). The stack must not extend more than 1500mm from the edge of the floor with its longest span perpendicular to the joists.

Stacking materials

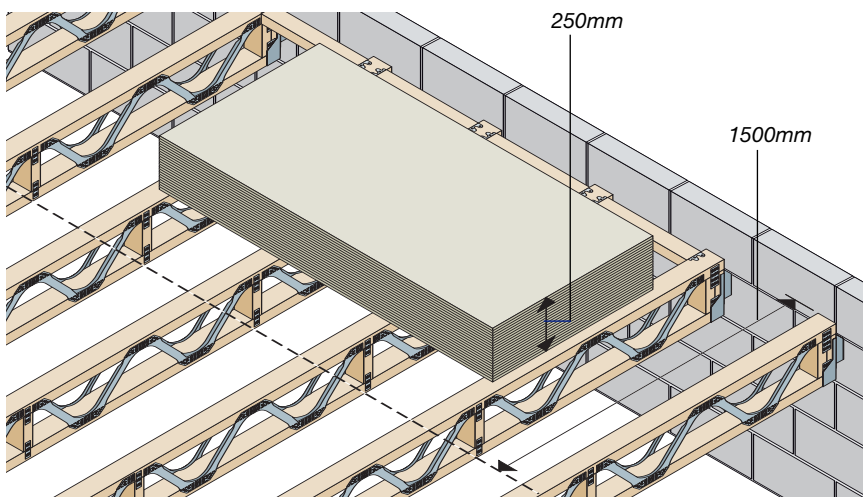

Lifting joists

Do not use chains or steel cable

Use fabric sling only

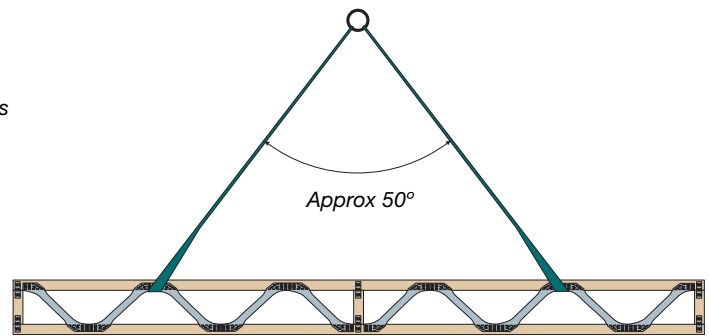

Safety:

- Use protective gloves when manually handling **easi-joists**.
- Refer to plans for joist weights, remembering to account for multiply girders.
- Observe health and safety regulations as set out by CDM2007.

Planning

- Study layout drawings and plan which section will be erected first, starting from which end. Identify girder joists and stair trimmer which will need to be installed first to provide support for others.
- Check support conditions for all joists ensuring all internal supporting walls are present and that all supporting masonry is cured.
- Identify joists by reference number and place them next to required areas. (joists should not be moved from dry storage until immediately before erection)

Installation:

- All joist are to be installed truly vertical, parallel and top side up.
- Refer to layout plans or profiles for the correct orientation of the joist.
- Noggins, restraint straps, decking and strongbacks should be properly installed to the specification of the manufacturer or designer.
- Where masonry hangers are used, ensure at least three courses of blockwork or equivalent have been laid and the mortar cured before the floor is used.
- Spacing and loading of **easi-joists** must not exceed that stated in the design.

Checking

- Ensure all joists are fully bearing on their supports, packing gaps if necessary.
- Check adjacent joists are level with each other and the ends of the joists form a straight line.



Health and Safety continued on page 32

Temporary erection bracing

The builder is responsible for identifying and minimising the risks involved in erecting open-web joists to ensure that the health and safety of workers is maintained. Builders should be aware of the health and safety responsibilities imposed on them by the Construction (Design and Management) Regulations 1994.

Proper erection procedures and bracing are vital to the safe construction of open-web joist floors.

The following notes may assist builders in preparing a safety assessment.

- Un-braced joists may be unstable.
- Do not allow anyone to walk on un-braced joists.
- Do not store building materials on un-braced joists.
- Open-web joists should be erected straight and vertical.
Horizontal deviation : 10mm max.
Vertical deviation: 2mm max.
- Temporary bracing comprises diagonal longitudinal binders and permanent strongbacks.

- All longitudinal binders, diagonal braces, strongbacks and hangers, should be completely installed and fully nailed as detailed.
- Lateral strength should be provided by a diagonally braced system across at least 3 joists as shown in the erection bracing diagram. Additional braced and blocked systems should be provided at 12m spacing in long joist runs.
- Construction materials may only be stored on joists when all bracing is in place. The material should be spread over at least 4 joists and not more than 1500m from a support. Floor/ceiling boards may be stacked up to 250mm high (150 kg per joist at 600mm centres, 100 kg per joist at 400mm centres) on braced floors.
- Flooring should be fully fixed to the joists before additional loads are placed on the floor.
- Temporary bracing may be progressively removed as decking is fixed.

Strongback details

Fix 75 x 38mm (min) blocks to top and bottom chords with 2.no. 65 x 3.35mm wire nails. Insert strongback through joists before fixing joists in position, as it may not be possible to do this at a later stage. Position strongback tight to underside of top flange. Fix 97 x 35mm (min) strongback to blocks with 2/no. 65 x 3.35mm wire nails.

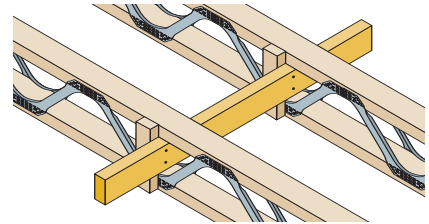

Fix 97 x 35mm (min) strongbacks to joists with 2/no. 65 x 3.35mm wire nails.

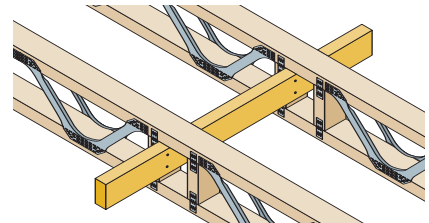

Extract taken from Code of Practice for Engineered Wood Products

Construction materials shall only be stored in the 1.5m edge zone at one end of the joist only.

Min 675mm cured masonry above hanger level or as advised by hanger manufacturer

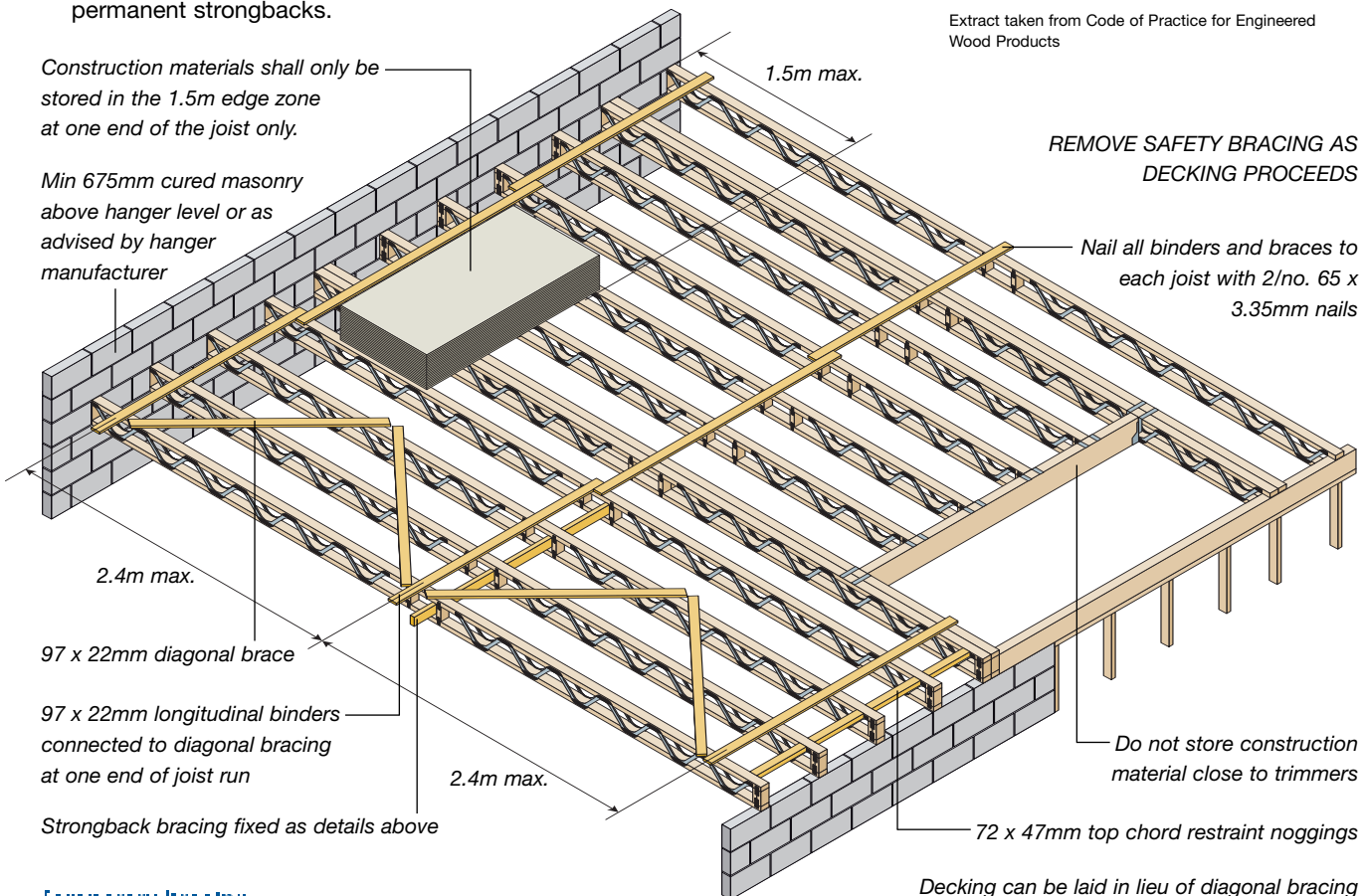

Temporary bracing

This diagram indicates temporary erection bracing only. It is applicable to both masonry and timber frame construction

Decking can be laid in lieu of diagonal bracing

Acoustic performance	10, 11, 12, 13	NHBC	2
Approvals	10	Noggin	24
Benefits	5	Partitions	18
Binder	22	Planning	31
Bracing	32	Preservative	5
Checking	31	Product range	7
Company history	2	Resilient bars	11
Connection details	22	Restraint strap	16, 24, 28
Contents	3	Rim board	25, 26, 27
Cullen	28	Ring beam	27
Damping	18	Robust Details	2, 11
Dead loads	18	Roof	29
Definitions	6	Safety	32
Deflection	16	SDS	28
Design service	35	Separating floors	10, 11, 13
LTA	2, 10	Service class	17
LWP	26, 27	Services	8
Features	5	Simpson	28
Fire resistance	11, 12, 13	Site	31
Floor makeup	11, 12, 13	Sizes	7
General arrangement	19	Software	35
Glossary	34	Span tables	14
Ground floor	17	Splicing	16
Handling	31	Stairs	18, 22
Hangers	22, 24, 28	Stiffness	18
Home Bond	2	Storage	31
IAB	2, 10	Strongback	9, 23, 32
Imposed loads	18	Support	35
Industry associations	2	SVP	24
Installation	31	Timber	5
Insulation	11, 13, 17	Timberframe details	25, 26, 27
Intermediate floors	10, 12	Timberlok	28
Introduction	5	TFA	2
ITF MA	2	TRADA	2
Ledgerlok	28	Training	35
Loading	18	Treatment	5
Masonry details	24	UKTIA	2
Material weights	18	Z clip	28
Metalwork	28		

Bearing	The area of a member receiving structural support.
Building Designer	The person responsible for the structural stability and integrity of the building as a whole.
Cantilever	The part of a structural member extending beyond the end support.
CDM Coordinator	
Chord	The horizontal timber members at the top and bottom of an easi-joist
Column	A vertical timber block fixed between the chords of an easi-joist.
Compartment Floor	Separating two dwellings and required to provide sound resistance and 1 hour fire resistance.
Compression Block	A vertical timber block fixed to the side of joists where substantial vertical loads are applied.
Dead Load	The load produced by the fabric of the floor structure.
Decking	Timber boarding providing the floor or roof surface.
Deflection	Vertical deformation due to loading.
Dwang	A structural member comprising of two chords with columns at set spacing.
Dwarf Wall	A load bearing timber frame wall of similar depth to the floor joists.
easi-joist®	An engineered joist made from stress graded timber chords fixed with galvanised steel webs.
EWP	Engineered Wood Product - a man-made composite timber product.
Header Binder	Horizontal length of timber fixed onto the top rail of a timber frame panel.
Imposed Load	The load produced by the occupancy of a building including storage and inhabitants.
Intermediate Support	Structural support within the span of a joist.
Line Load	A UDL applied along a single line.
Live Load	Also known as IMPOSED LOAD.
Noggin	A horizontal timber block fixed between the chords of adjacent joists.
OSB	Oriented Strand Board - a composite product made from strands of wood and glue.
Partition Wall	Timber framed non-load bearing wall applying a load to the floor below.
Point Load	A force applied at a single position.
Rim Board	A product used on the perimeter of a building to enclose the floor structure.
Ring Beam	A structural beam used to distribute floor loads evenly to the walls below.
Services	Pipe work, ducting and cables laid within the floor zone.
Sheathing	OSB or plywood sheets nailed to timber frame panels to provide racking resistance.
Span	The overall length of a joist.
Strongback	A structural timber fixed perpendicular to a run of easi-joists® to reduce deflection.
SVP	Soil Vent Pipe.
Trimmable End	Timber allowed for tolerance which can be removed without compromising the joist.
Trimmer	A structural member framing a floor opening.
UDL	Uniformly Distributed Load - either an area load (N/sq.m) or a line load (N/m).
Web	A diagonal galvanised steel strut fixed into the chords of an easi-joist with pressed nails.

DISCLAIMER: The information contained in this guide is supplied in good faith but without liability and its use is entirely at the discretion of the user

Version Date: June 2008

Support

From our UK headquarters in Coventry, Wolf Systems supports a network of **easi-joist**[®] manufacturers across the UK and Ireland.

A team of highly trained and experienced personnel provide technical, practical and commercial solutions for our manufacturers and their customers.

We use the latest internet based support packages together with on-site support services to ensure **easi-joist**[®] manufacturers receive comprehensive and relevant support and assistance.



Software

easi-joist[®] metalweb floor joists are designed and detailed using computer design software which is written by Wolf Systems. We have extensive knowledge of producing technically expert user-friendly design software for timber engineering applications and our experience in this area is certainly of benefit to our customers and manufacturers.

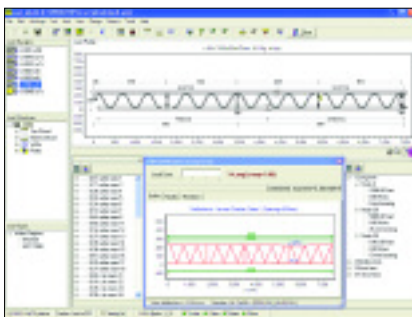

All of our software is written in the UK for the UK and Irish markets, allowing us to tailor our applications to meet the demands of the local environment and ensure **easi-joist**[®] manufacturers have the tools they need to quickly and easily design and manufacture their products.

Design Service

Wolf Systems also provides manufacturers with a design service for projects using **easi-joist**[®] metal web joists.

Using the skills and experience of our own in-house design team, Wolf Systems offer a floor design service from initial feasibility study to final construction drawing and detailing. This service assists the manufacturer, contractor and client by providing all the information necessary to achieve a quickly and easily installed **easi-joist**[®] floor.

Training

All licensed **easi-joist**[®] manufacturers receive training in the use of our design software and good floor design practice. This training takes place in a dedicated training suite at Wolf Systems' Offices.

Manufacturers also receive ongoing training to keep them up to date with relevant building regulations and technical issues as well as with important advances in our design software.

Additional training is also provided for manufacturers' sales and service staff to ensure they are aware of the benefits **easi-joist**[®] has over more traditional flooring methods, so these can be passed onto their customers.



easi-joist[®] TECHNICAL GUIDE

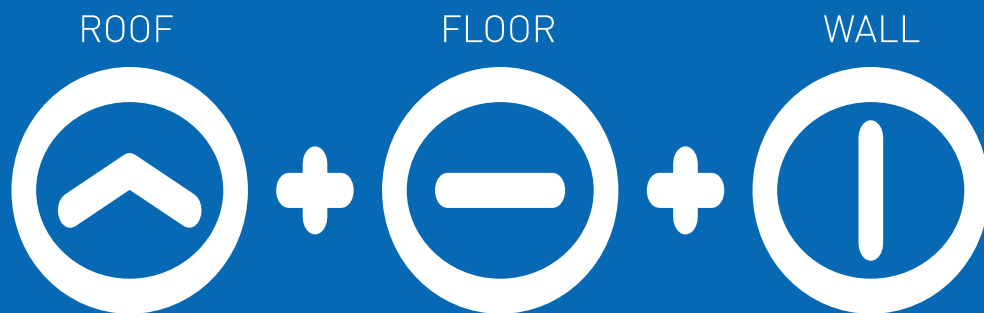

WHOLE HOUSE TIMBER ENGINEERING SOLUTIONS.

Manufactured and Supplied By:



WOLF SYSTEMS LIMITED

Shilton Industrial Estate Shilton Coventry CV7 9QL
T +44 (0)2476 602 303 E mail@wolfsystem.co.uk
WWW.WOLFSYSTEM.CO.UK